





The chair "Production Engineering of E-Mobility Components" (PEM) of RWTH Aachen University has been active in the field of lithium-ion battery production technology for many years. These activities cover both automotive and stationary applications. Through a multitude of national and international industrial projects with companies at every level of the value chain as well as key positions in renowned research projects, PEM offers extensive expertise.



**PEM**  
Production Engineering of E-Mobility  
Components of RWTH Aachen University  
Bohr 12  
52072 Aachen

[www.pem.rwth-aachen.de](http://www.pem.rwth-aachen.de)

The VDMA represents more than 3,700 German and European mechanical and plant engineering companies. The Battery Production specialist department is the point of contact for all questions relating to battery machinery and plant engineering. It researches technology and market information, organizes customer events and roadshows, offers platforms for exchange within the industry, and maintains a dialog with research and science.



**VDMA**  
Battery Production  
Lyoner Straße 18  
60528 Frankfurt am Main

<https://vdma.org/battery-productionequipment>

## Authors

### PEM of RWTH Aachen University

**Prof. Dr.-Ing. Dipl.-Wirt.-Ing.  
Heiner Hans Heimes**

Member of Institute Management  
h.heimes@pem.rwth-aachen.de

**Benjamin Dorn, M.Sc.**

Chief Engineer  
Battery & Electric Drive Production  
b.dorn@pem.rwth-aachen.de

**Daniel Neb, M.Sc.**

Group Lead  
Battery Production Management  
d.neb@pem.rwth-aachen.de

**Henning Clever, M. Sc.**

Research Associate  
Battery Production Management  
h.clever@pem.rwth-aachen.de



**Artur Scheibe, M. Sc.**

Research Associate  
Battery Production Technology  
a.scheibe@pem.rwth-aachen.de

### VDMA



**Dr. Sarah Michaelis**

Division Manager  
VDMA Battery Production  
Sarah.Michaelis@vdma.org

**Jörg Schütrumpf**

Project Manager  
VDMA Battery Production  
Joerg.Schuetrumpf@vdma.org



**Do you have any questions?**

**Contact us!**



Frankfurt am Main, July 2023  
PEM of RWTH Aachen University & VDMA,  
In-house printing, 4th edition  
ISBN: 978-3-947920-45-7

# Motivation

## Battery module and battery pack production

- With their ability to efficiently store large amounts of energy temporarily and then make them available as needed, battery systems in the form of battery modules and battery packs play a key role in the energy supply of the future.
- This is not only due to the increasing demand for electric vehicles and stationary energy storage systems, but also to the recognized need to drive the energy transition and reduce dependence on fossil fuels.

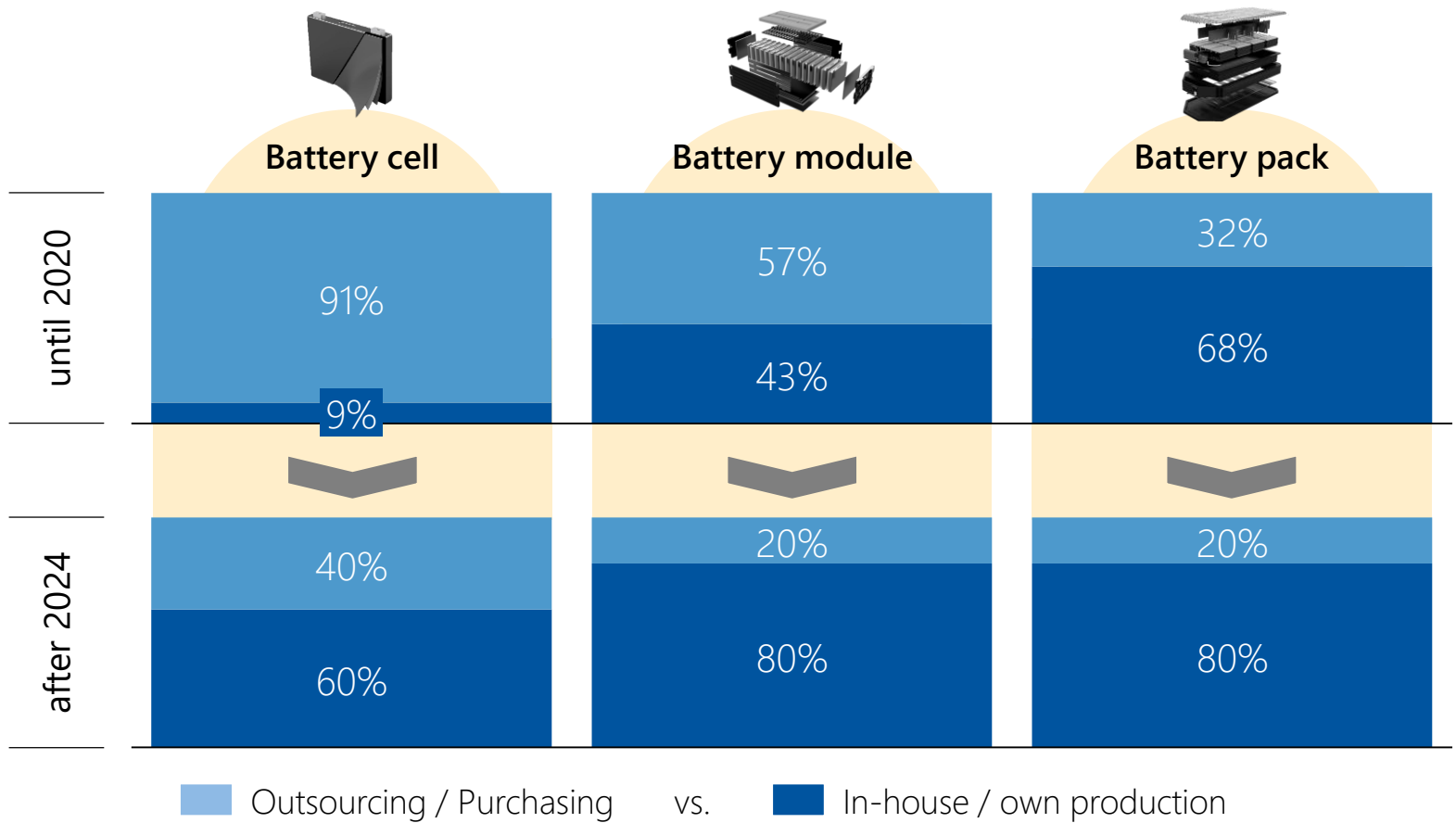

- The development and production of battery storage systems is thus a promising and future-oriented branch of industry with considerable economic potential.

# Battery value chain

## Overview of the production sequence from cell to system

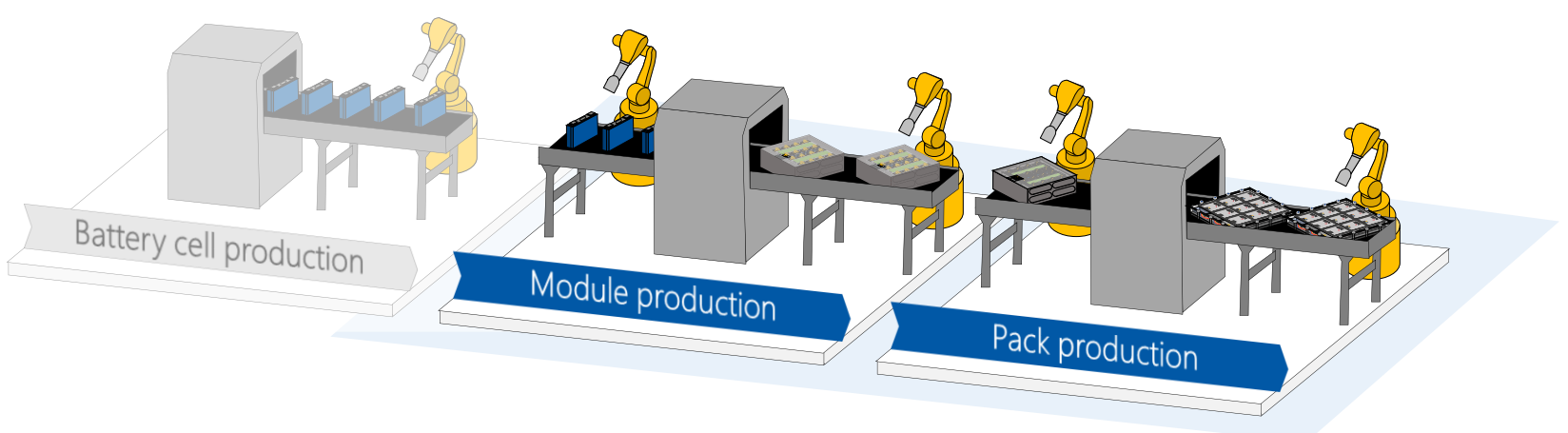

- Based on the brochure "*Production process of lithium-ion battery cells*", this brochure presents the process chain for the production of battery modules and battery packs.
- The individual cells are connected in series or parallel in a module. Several modules and other electrical, mechanical and thermal components are assembled into a pack.

# Fundamentals battery module

## Comparison of different module configurations



### Battery module made of pouch cells

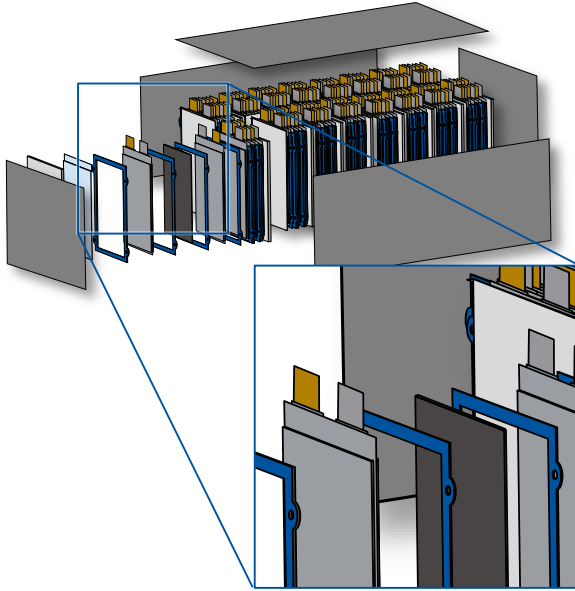

- Battery modules made of pouch cells are designed so that the cells are stacked on top of each other and then interconnected.
- Due to their flexible envelope, the individual pouch cells can be placed in a frame beforehand.
- Gap filler for volume compensation or active and passive cooling elements can be inserted between the cells.
- The cell stack is braced in different ways and placed in the module housing.
- The volume expansion ("breathing") of the pouch cells during charge or discharge cycles must be taken into account in the module design.

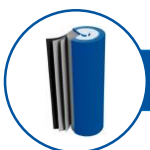

### Battery module made of cylindrical cells

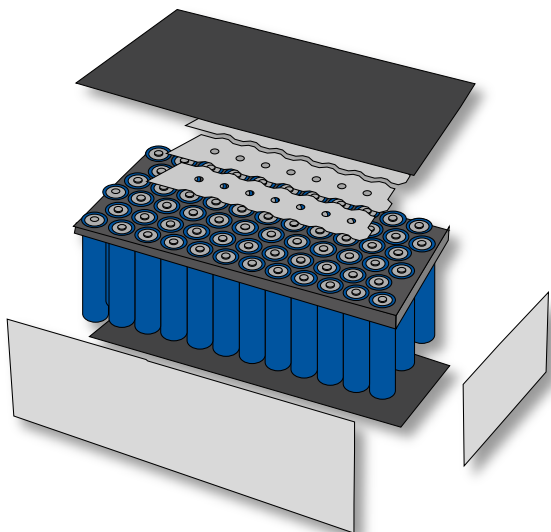

- In the architecture of a round cell module, the cells are fixed in the module housing via cell holders.
- The round cells are contacted by busbars (metal plates) on the top and bottom side and connected in a combination of series and parallel circuits.
- Due to the format, there are gaps between the round cells. A wave-shaped cooling system is used to maximize the surface area for heat dissipation.
- The solid metal housing reduces cell breathing and increases structural integrity.
- The standardization of round cells as well as their comparatively low prices due to large production scales are the reason for their widespread use as a standard solution in battery modules.

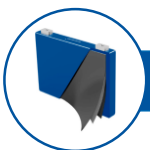

### Battery module made of prismatic cells

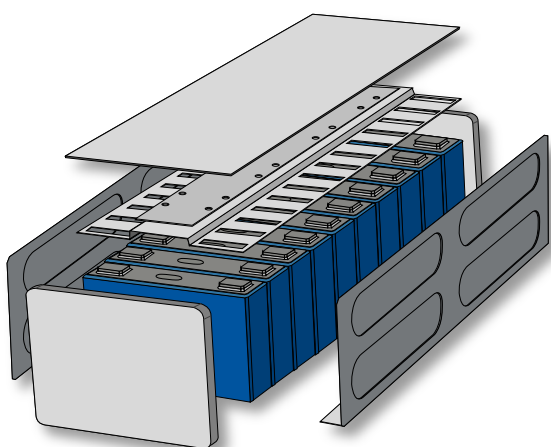

- Prismatic cells can be stacked on top of each other without any remaining gaps.
- The individual cells are bonded together by means of adhesive films. In addition, pads or gap filler can be inserted between the cells.
- The filler materials between the cells can perform several functions, including thermal insulation in the event of an accident, vibration protection, compensation for unevenness and volume changes.
- Analogous to the pouch cells, the cell stack is braced, contacted and inserted into the module housing.

# Fundamentals battery pack

Integration and future trends at system level

## Traditional battery architectures

### Cell-to-Module-to-Pack:

- For the xEV segment, the classic system architecture consisting of cell, module and pack has largely established itself. Current pack systems still offer significant potential for increasing energy density at pack level.
- Today's technological developments specifically address the integration of battery cells in order to further optimize the overall system in terms of energy density, safety and durability.
- Resulting product and process innovations also pursue the goals of reduced production costs and efficient assembly processes.

*Traditional battery architectures show great potential for improvement in terms of energy density, safety, longevity and production costs.*

## State of the art

Source: Helmholtz Institut Ulm Geladen podcast (Cell-to-Pack vs. Cell-to-Chassis) 2022

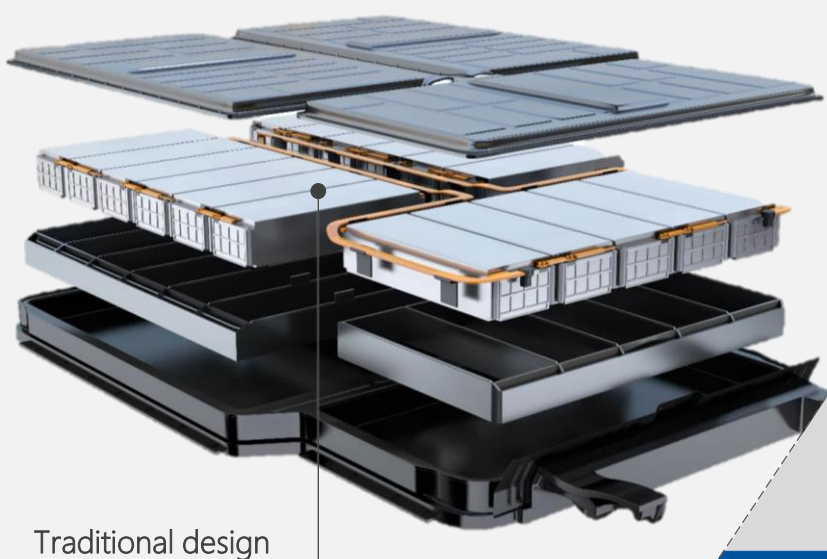

Source: Henkel Adhesive Technologies (Henkel Solutions for EV Battery Systems) 2022

## Next generation

### Cell-to-Pack ← → Module-to-Chassis ← → Cell-to-Chassis

- Cells are integrated directly into the battery pack and the module level is skipped.
- Reduction of the required components and the overall costs.
- Increase in volumetric energy density at pack level.
- Modules can also be used as a standard level and integrated directly into the chassis.

- Cells are integrated directly into the chassis and only the most essential intermediate elements remain. The pack level is skipped.
- The battery concept is fully aligned with the vehicle.
- Thus, the highest energy densities can be realized in this design.
- However, this system architecture poses the greatest complexity.

## Future battery architectures

*Future battery architectures increasingly rely on integrative design strategies to reduce components and increase energy density.*

# Begin-of-line testing

## Module production

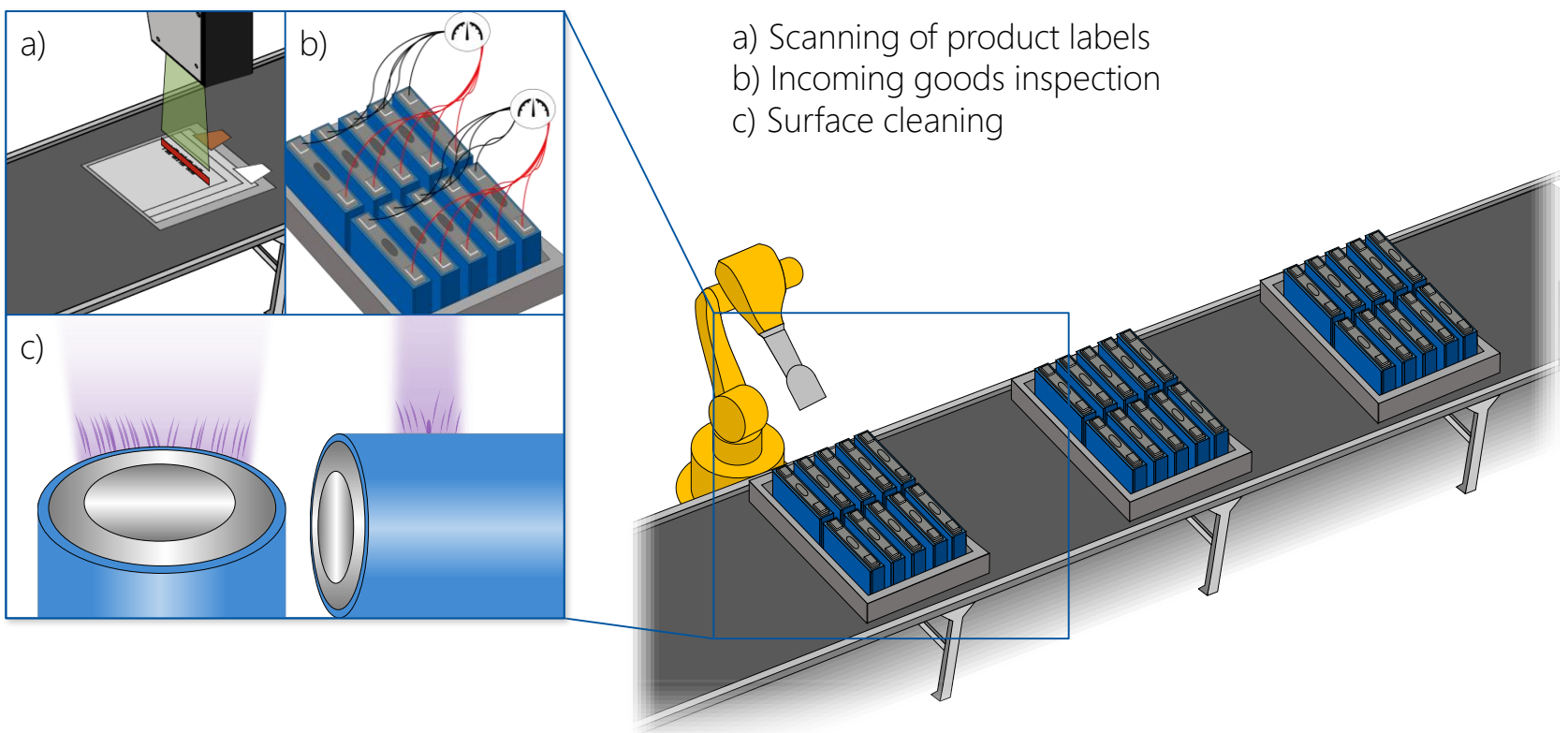
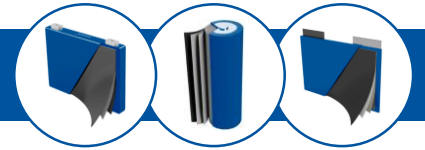

Pack production

### Production process

- Automated removal of the delivered battery cell from the transport container and placement on conveyor system (e.g. belt / roller conveyor).
- Scanning of product labels and sorting according to performance data (e.g. cell model, part number (DMC), electrical and, if applicable, mechanical classification).
- Incoming goods inspection to sort out defective / non-conforming cells (e.g. via optical inspection such as cameras or laser triangulation, electrochemical impedance analysis, voltage measurement, capacity analysis and other measurements).
- Sorting of the cells according to their performance specification, ensuring that all modules are evenly balanced (e.g. by compensating for deviating cell capacity)
- Depending on the delivery condition, cleaning (e.g. laser cleaning, plasma treatment, CO<sub>2</sub> snow-jet cleaning) and activation of the surfaces takes place in preparation for the subsequent application of the adhesive or the insulation foil.

#### Process parameters & requirements

- Safe and precise handling of the battery cells with end of arm tooling
- Testing of cells for open circuit voltage (OCV), capacity, internal resistance, insulation resistance, electrochemical impedance
- Suppliers' delivery quality determines the scope of testing

#### Quality parameters

- Scanning of cells for complete traceability throughout the entire production via RFID and cameras
- Reliable detection of defective or nonconforming cells
- Technical cleanliness: dust and grease-free surface of the cells

#### Current technology alternatives

- Manufacturer-specific test sequences and test durations
- Transport via goods carriers with integrated measurement technology

#### Innovations / Trends

- Multi-channel testing to reduce test duration
- AI applications for detection of deviation patterns
- Inline quality assurance

Production costs\* [excerpt]

Investment for machinery & equipment: € 1.2 – 1.5 m

\* PEM study by RWTH Aachen University: Capacity of the pack: 150 Ah, pack voltage: 400 V, production capacity: 4 GWh/a

# Stacking the cells

## Module production

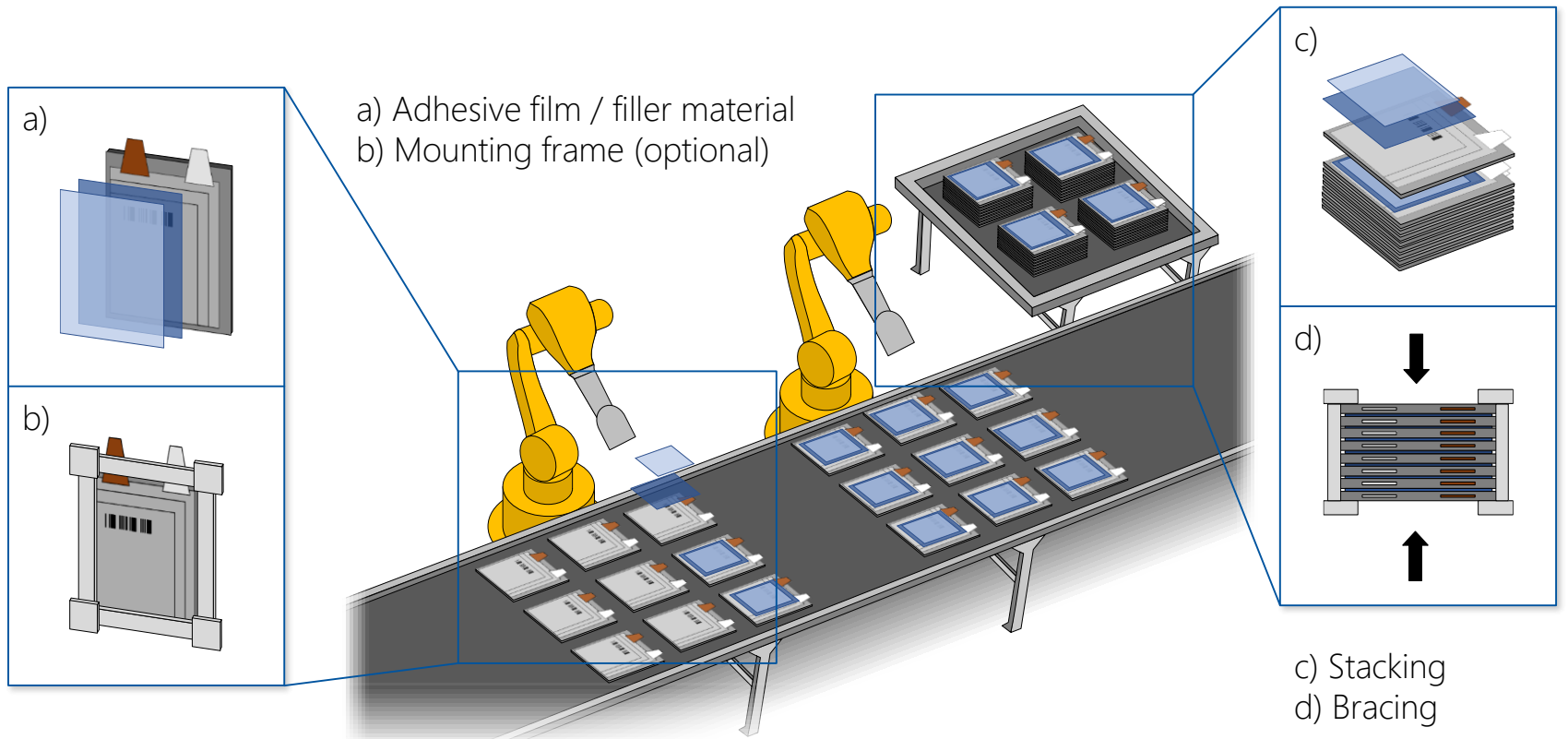
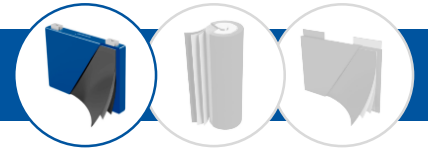

### Pack production

#### Production process

- Pre-bending and cutting of cell tabs depending on the cell's position in the stack.
- Application of adhesive film and filler material (e.g. thermal interface material) on the cleaned cell surface.
- *Optional:* Insertion of the pouch cells into a holder / frame element, which brings the cells into a defined distance to each other, minimizes volume expansion during respiration and protects the flexible cell housing from damage.
- The cells are then stacked (cell-to-stack). Stacking tables ensure a defined stacking geometry, for example by means of centering mandrels.
- *Optional:* Additional gap pads are applied during the stacking process.
- The cell stack is finally tensioned to obtain a defined surface pressure and to reduce the cyclic volume expansion during operation (swelling).

#### Process parameters & requirements

- Contact pressure of the gripping system or end of arm tooling
- Dosing and application accuracy of the adhesive
- Maximum pressure forces during clamping
- Short process times due to reactivity of the adhesive

#### Quality parameters

- Damage-free handling
- Positional accuracy of adhesive film and / or gap pad
- Uniform pressure distribution following tensioning
- Stack height and geometry according to given specification

#### Current technology alternatives

- Dispensing system or double-sided film for adhesive application
- Additional frame / holder systems for holding single or multiple pouch cells

#### Innovations / Trends

- Higher level of automation in assembly and quality control
- Sustainable joining technologies for unproblematic disassembly and recycling

Production costs\* [excerpt]

Investment for machinery & equipment: € 2.8 – 3.5 m

\* PEM study by RWTH Aachen University: Capacity of the pack: 150 Ah, pack voltage: 400 V, production capacity: 4 GWh/a

# Stacking the cells

## Module production

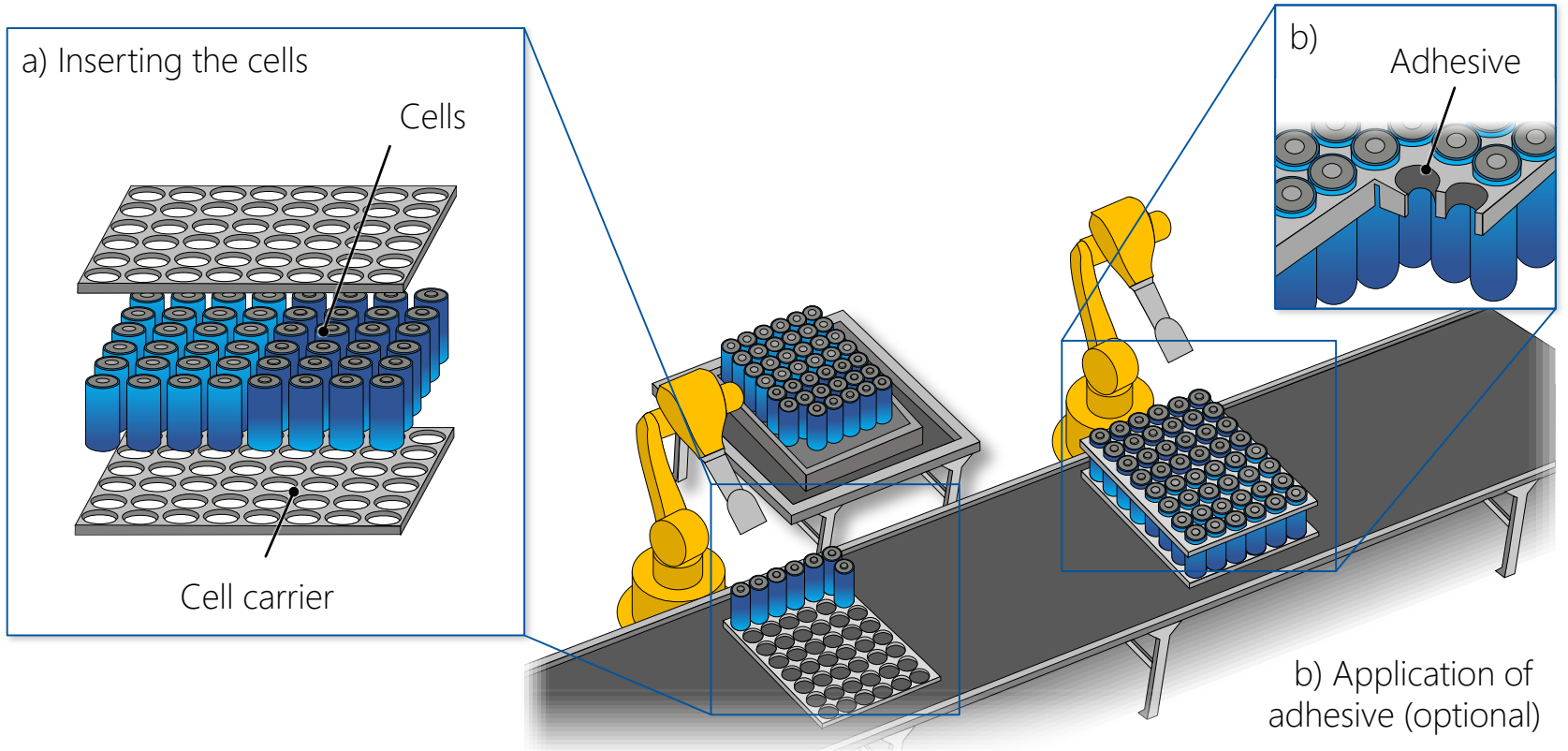
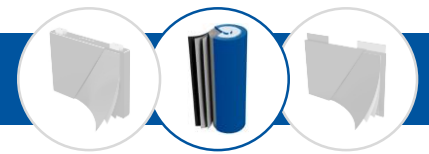

### Pack production

#### Production process

- Insertion of the individual round cells into the formed recesses of the lower cell tray.
- Consideration of the polarity or orientation of the round cell during insertion in order to ensure subsequent electrical connection in series / in parallel according to specification.
- *Optional:* Fixation via upper cell holder.
- *Optional:* Application of adhesive in the contact area between cell and cell insert for additional fixation.
- *Optional:* Application of curing foams as functional filler in additional cell interstices.
- Provision of sufficient curing time depending on the adhesive or filler material used.

#### Process parameters & requirements

- Positioning accuracy and precise alignment of the battery cells
- Dosing and application accuracy of the adhesive
- Process design considering curing times (e.g. of the adhesive)

#### Quality parameters

- Compliance with specified geometry tolerances
- Correct installation direction and polarity of the cells
- Uniform distribution of the adhesive and filler material
- Secure fixation of the cells

#### Current technology alternatives

- Alternative fixation methods such as clamping, hot caulking, bolting, bracing

#### Innovations / Trends

- Higher level of automation in assembly and quality control
- Sustainable joining technologies for unproblematic disassembly and recycling

Production costs\* [excerpt]

Investment for machinery & equipment: € 2.8 – 3.5 m

\* PEM study by RWTH Aachen University: Capacity of the pack: 150 Ah, pack voltage: 400 V, production capacity: 4 GWh/a



# Stacking the cells

## Module production

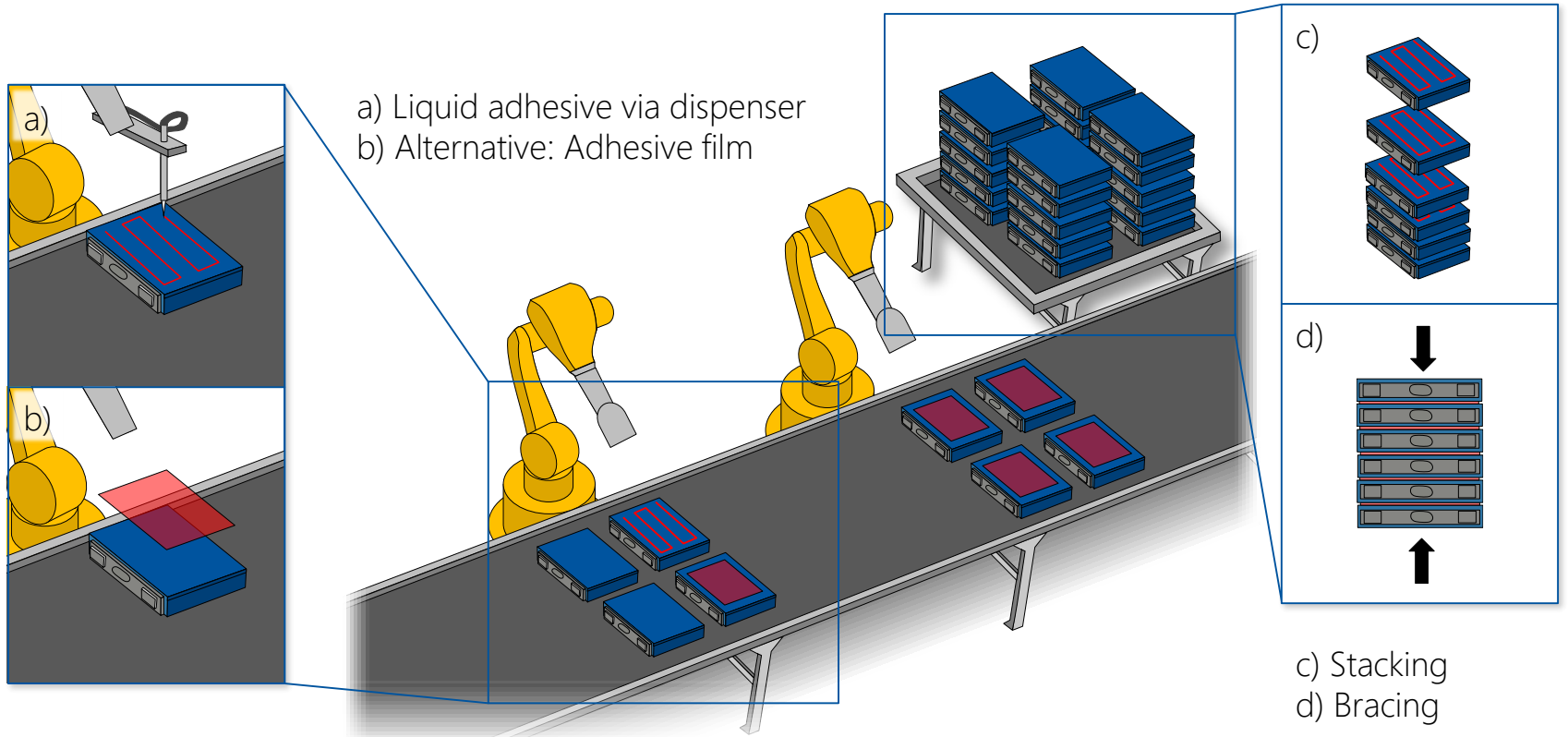
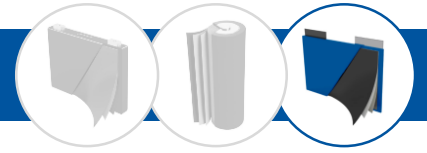

### Pack production

#### Production process

- Joining of cells by liquid or solid adhesives. The adhesive is applied to the cell surface by means of a fully automatic dispensing system or adhesive film.
- Common polyurethane-based adhesives have an electrically insulating effect and provide elastomeric properties after curing.
- Depending on the adhesive, solvent vapor extraction is required.
- The cells are then stacked (cell-to-stack). Stacking tables ensure a defined stacking geometry, for example by means of centering mandrels.
- *Optional*: Additional gap pads are applied during the stacking process.
- The cell stack is finally pressed to obtain a defined surface pressure and to reduce the cyclic volume expansion during operation (swelling).

#### Process parameters & requirements

- Contact pressure of the gripping system or end of arm tooling
- Dosing and application accuracy of the adhesive
- Maximum pressure forces during clamping
- Short process times due to reactivity of the adhesive

#### Quality parameters

- Damage-free handling
- Positional accuracy of adhesive film or filler materials (e.g. gap pads)
- Uniform pressure distribution following the pressing operation
- Stack height and geometry according to given specification

#### Current technology alternatives

- Dispensing system or double-sided adhesive film for adhesive or sealer application

#### Innovations / Trends

- Higher level of automation in assembly and quality control
- Sustainable joining technologies for unproblematic disassembly and recycling

Production costs\* [excerpt]

Investment for machinery & equipment: € 2.8 – 3.5 m

\* PEM study by RWTH Aachen University: Capacity of the pack: 150 Ah, pack voltage: 400 V, production capacity: 4 GWh/a

# Mounting the BMS

## Module production

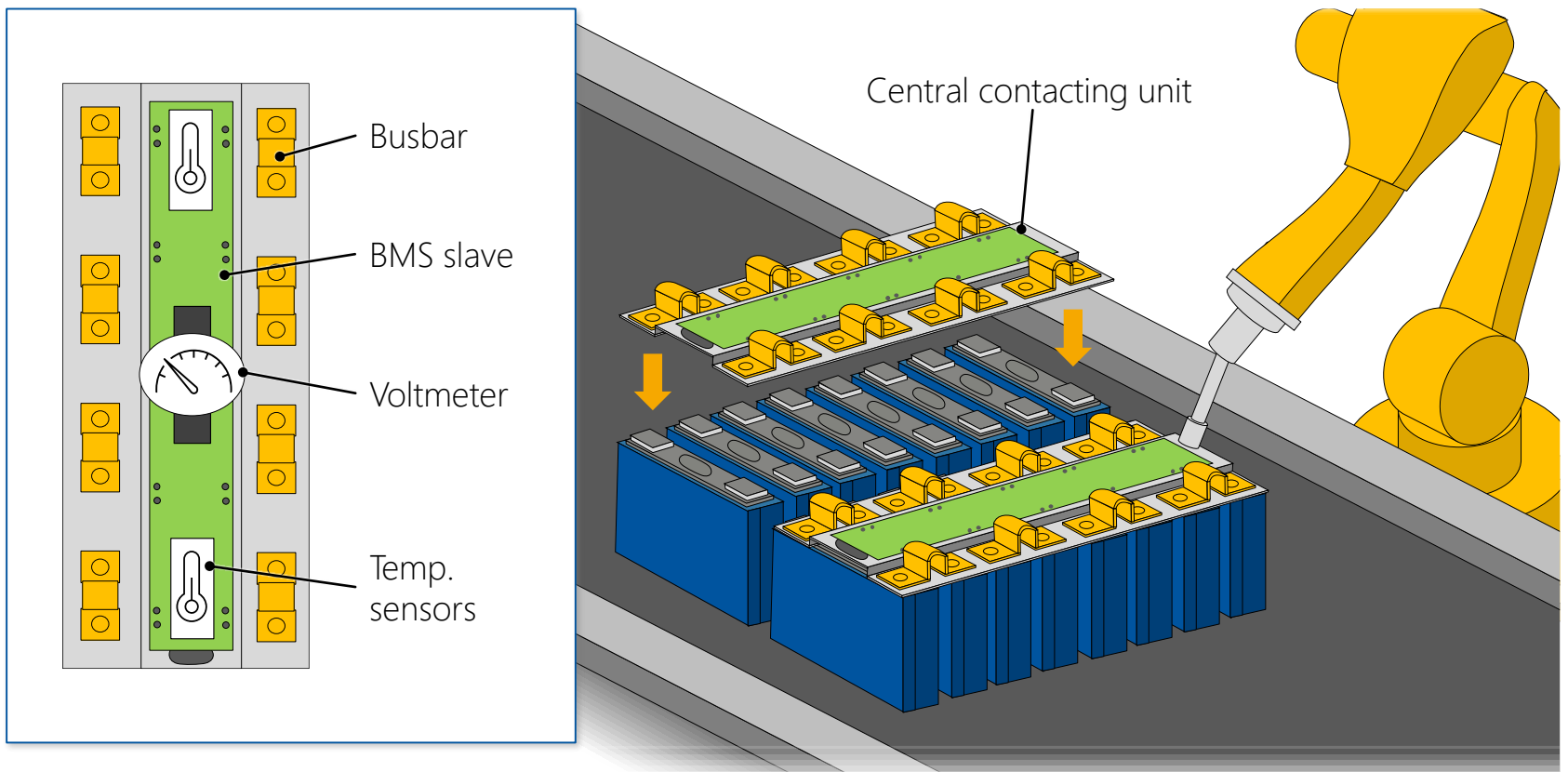
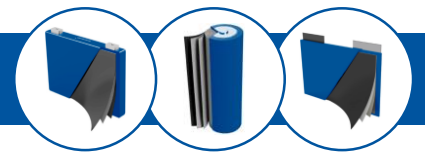

Pack production

### Production process

- Positioning of the battery management system (BMS) board or a central contacting unit, which is responsible for processing the data and controlling the sensors.
- Joining the BMS board and the contacting unit to the module by a welding process and / or screw connections.
- Mounting of the voltage measuring leads and the temperature sensors by clip fasteners or screw connection.
- Connecting the sensors to the board by means of plug-in connections.
- Function test by signal check and random inspection (e.g. optical inspection) of the BMS slave board.

#### Process parameters & requirements

- Damage-free handling of the board and sensors used
- Low heat input in the joining process (welding)

#### Quality parameters

- Positioning accuracy of sensors and printed circuit boards (PCB)
- Quality of the joints
- Measuring accuracy of sensors
- Robust signal processing
- Reliable shielding against external influences

#### Current technology alternatives

- Laser welding
- Bolting
- Plug-in connection
- Flexible Printed Circuits (FPC)

#### Innovations / Trends

- BMS slave boards with additional functions and sensors for voltage diagnostics, state-of-charge detection, balancing, etc.
- Wireless BMS concepts

Production costs\* [excerpt]

Investment for machinery & equipment: € 0.6 – 0.8 m

\* PEM study by RWTH Aachen University: Capacity of the pack: 150 Ah, pack voltage: 400 V, production capacity: 4 GWh/a

# Battery management system

Optimizing battery efficiency, safety and range

## Function of the battery management system (BMS)

- The battery management systems (BMS) acts as a control unit for the cells in the battery system. It monitors and controls factors such as voltage and temperature.
- It consists of a master module at pack level and several slave modules at module level.
- Battery management systems monitor the state-of-charge (SOC), state-of-health (SOH) and state-of-function (SOF) and optimize cell utilization and efficiency.
- In addition to mechanical safety mechanisms, the BMS can also detect damage and, for example, trigger HV contractors on impact.

*The BMS acts as the "brain" of the battery pack, actively controlling the battery cells and units. It prevents system failures and maximize energy efficiency.*

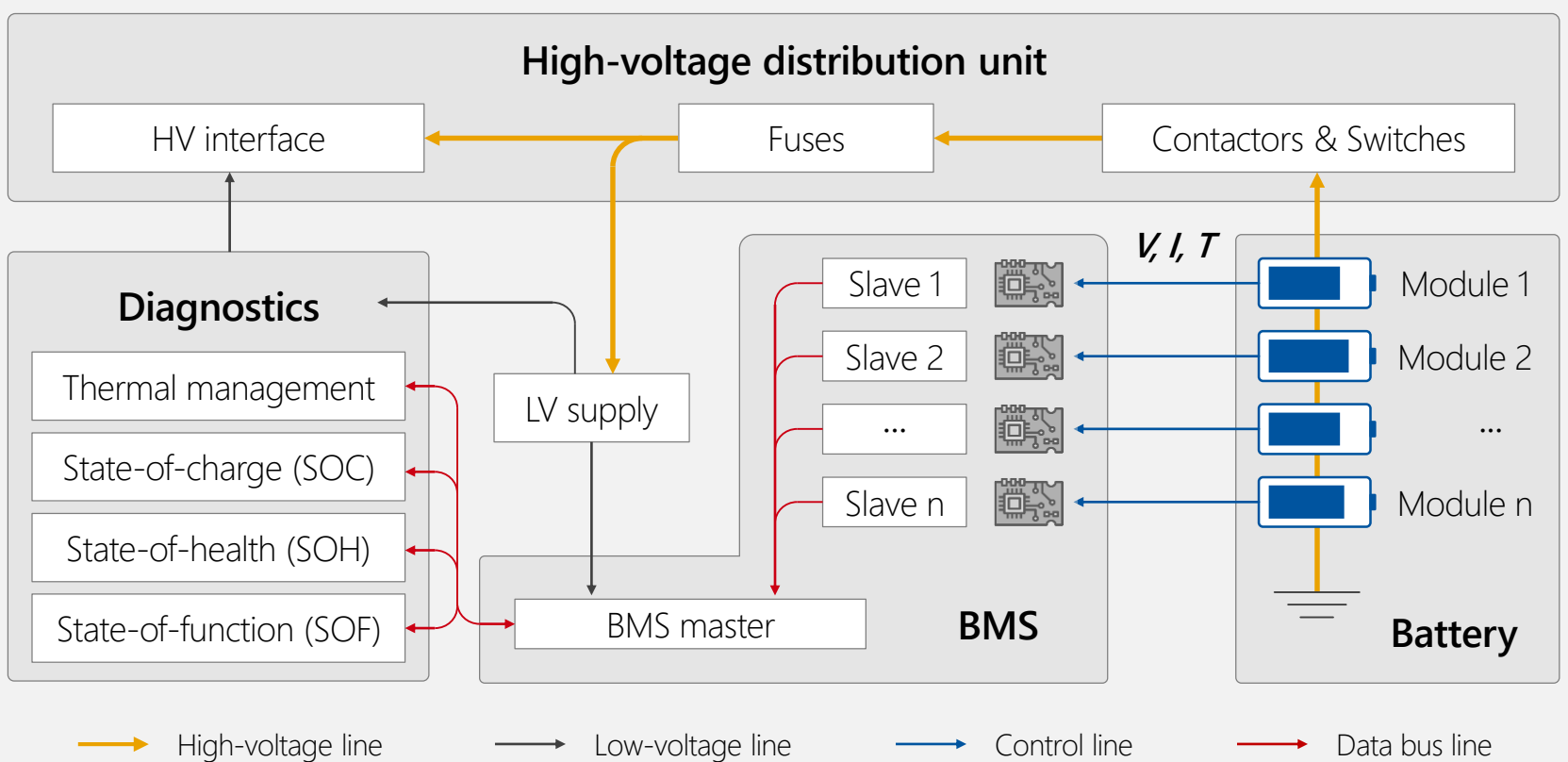

## Future integration of the BMS

- Traditional implementations of the BMS slave include connecting the battery cells to a central board using separate cable connections or flexible printed circuits.
- A trend towards decentralized BMS implementations with integrated circuit boards to allow individual monitoring of each cell and compact design is noticeable.
- In addition, the BMS is increasingly networked with the vehicle system to ensure seamless integration and precise energy management.

Central contacting unit

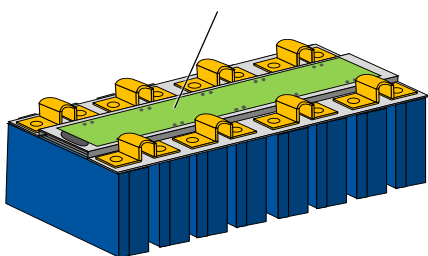

Flexible printed circuit

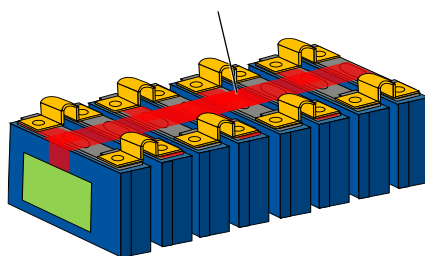

Decentralized BMS slave

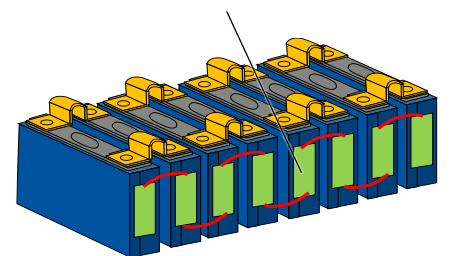

*Future battery management systems will rely on modularity and scalability, intelligent data analysis and networking with the entire vehicle.*

# Contacting the tabs

## Module production

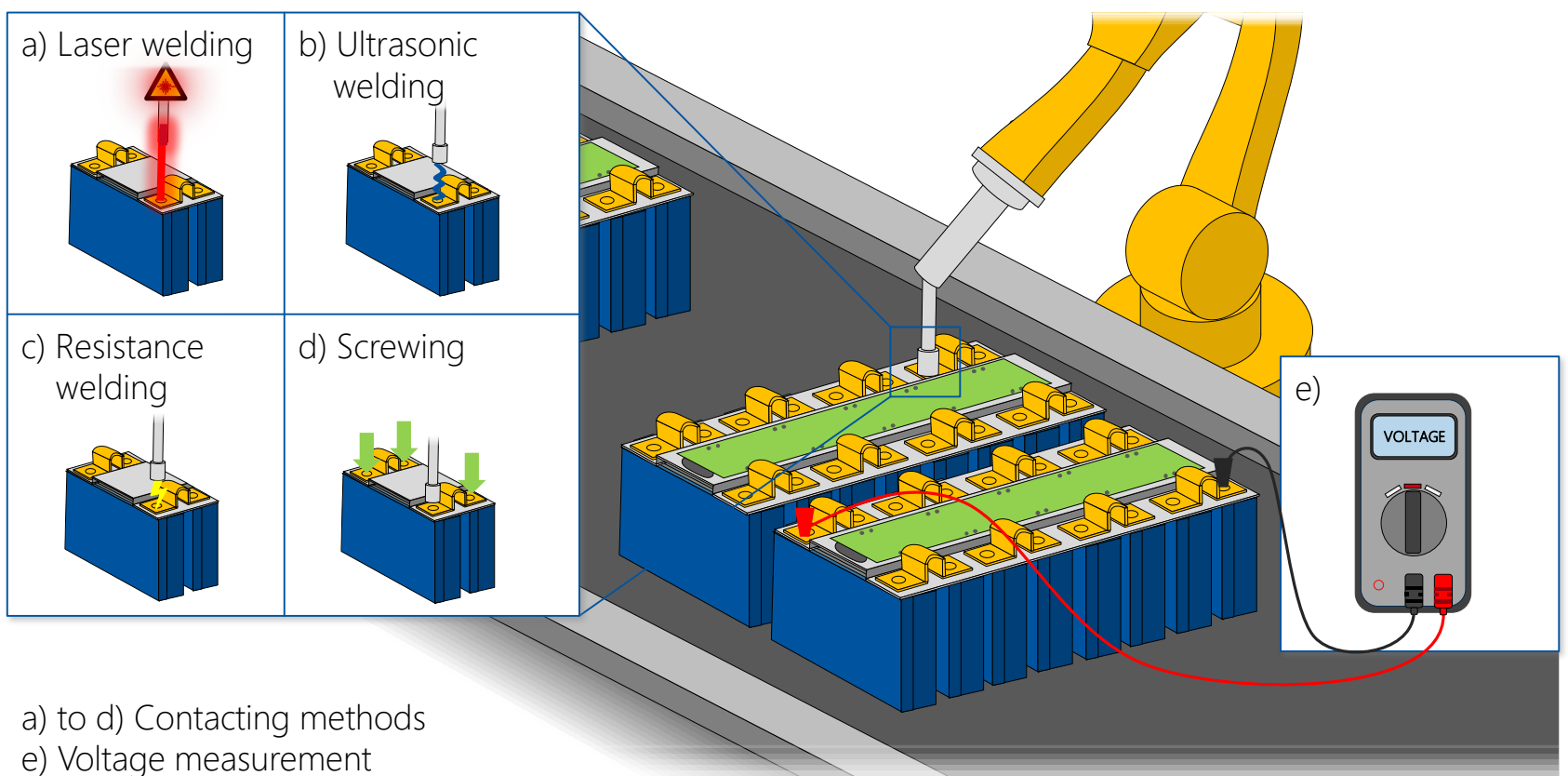
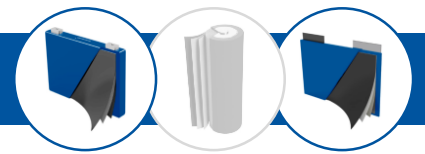

a) to d) Contacting methods  
e) Voltage measurement

Pack production

## Production process

- Surface cleaning to remove critical particles that pose a potential safety risk.
- Positioning of the busbars for electrical contacting and interconnection of the battery cells. Alignment of the cell arresters (e.g. tab bending) in preparation for the joining process.
- Series or parallel wiring of the battery cells by electrically conducting connection of the arresters. The actual connection in serial and parallel strings results from the specified module voltage and capacity.
- The joining process can be carried out by means of screw connections, ultrasonic, laser or resistance welding.
- The joining or connection points are then checked (e.g. by resistance measurements for conductivity). With a high degree of automation, it is possible to inspect the weld seams during the welding process by means of an optical check.

### Process parameters & requirements

- Seams must be free of dust and grease and have low reflections for laser welding
- Ultrasonic welding: 20 – 40 kHz frequency, 10 – 50  $\mu\text{m}$  amplitude, and 1 – 10 MPa pressure
- Laser welding: 1000 – 4000 W power
- Low heat input into the cell

### Quality parameters

- Precise positioning of the busbars and contact lugs for optimum joining results
- Weld seam and joint quality
- High electrical conductivity in all joints

### Current technology alternatives

- Laser welding widely used due to flexibility, material compatibility and short process times
- Ultrasonic welding offers a significantly lower heat load

### Innovations / Trends

- Real-time analytics for defect detection and prevention

Production costs\* [excerpt]

Investment for machinery & equipment: € 6.5 – 11.0 m

\* PEM study by RWTH Aachen University: Capacity of the pack: 150 Ah, pack voltage: 400 V, production capacity: 4 GWh/a

# Contacting the tabs

## Module production

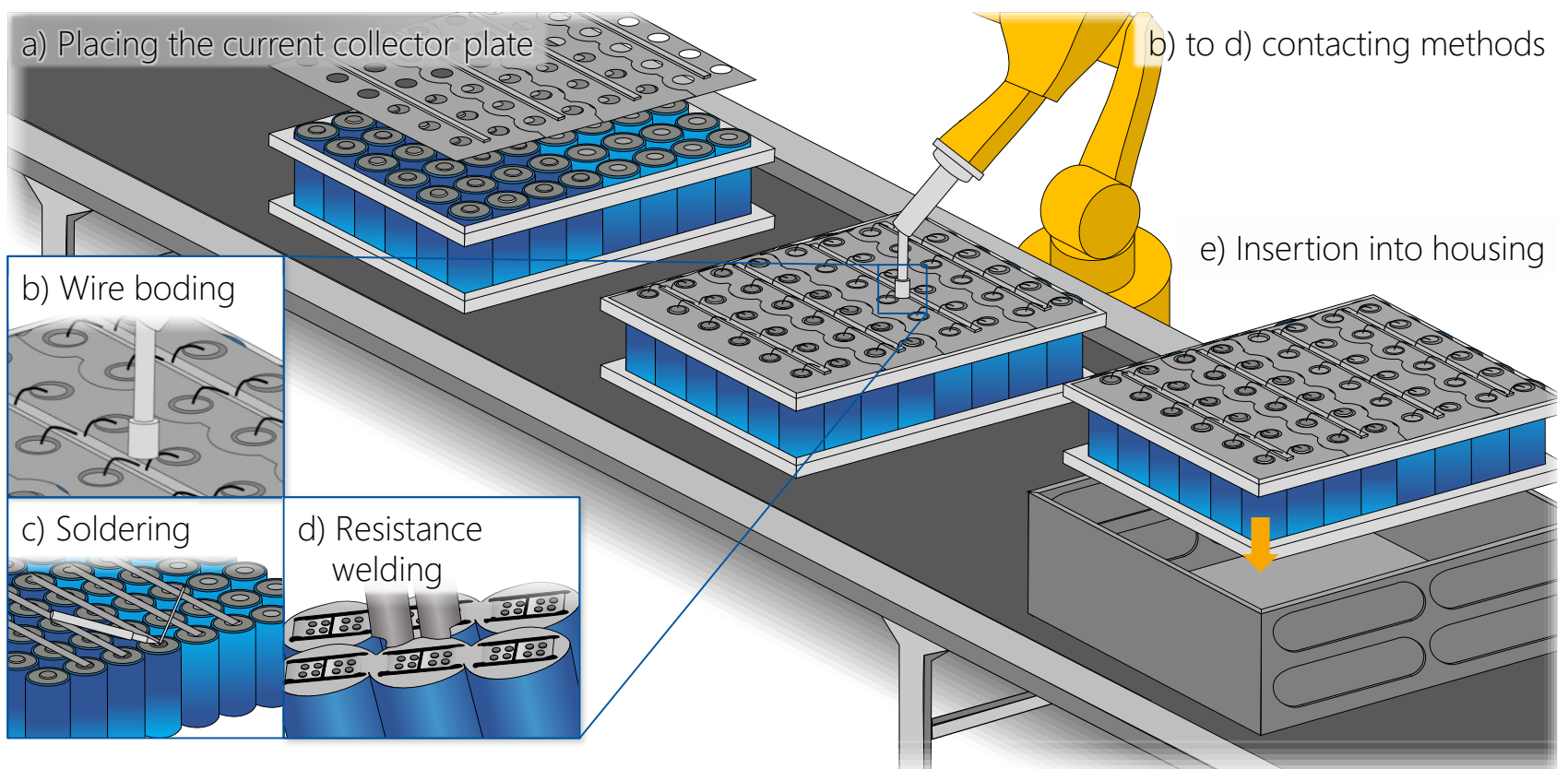
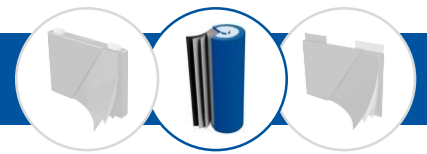

Pack production

### Production process

- Surface cleaning to remove critical particles that pose a potential safety risk.
- Aligning, placing and fixing the current collector plates or busbars on the top and bottom of the plugged round cells. The busbar must be firmly connected to the cell carrier by means of adhesive bonding, bolting or alternative joining processes such as hot caulking to ensure an optimum connection.
- The cell tabs are electrically contacted with the current collector plates. Contacting for example by wire bonding via aluminum wires (with a diameter of 200 - 300  $\mu\text{m}$ ) or resistance spot welding.
- Preparation of the module housing by inserting interface material for heat dissipation and electrical insulation (e.g. pads, foils or fluids).
- Insertion of the electrically connected round cell composite into the module housing.

#### Process parameters & requirements

- Positional accuracy of the current collector plates
- Positional accuracy of the cell bond in the module housing
- Material-matched wire bond parameters (voltage, current, etc.)

#### Quality parameters

- Weld seam and joint quality
- Electrical conductivity and mechanical stability of the connection
- Heat dissipation and electrical insulation of the interface material
- Compliance with tight tolerances for high assembly quality

#### Current technology alternatives

- Alternative contacting methods such as laser welding, resistance welding, soldering

#### Innovations / Trends

- Real-time analytics for defect detection and prevention

Production costs\* [excerpt]

Investment for machinery & equipment: € 6.5 – 11.0 m

\* PEM study by RWTH Aachen University: Capacity of the pack: 150 Ah, pack voltage: 400 V, production capacity: 4 GWh/a

# Comparison of welding processes

## Module production

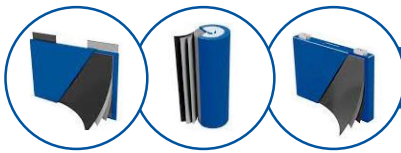

### Laser welding

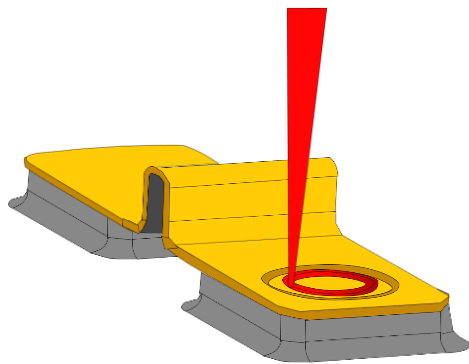

- A laser heats the arrester and the contact sheet until they are fused due to fast energy supply resulting in short process times.
- The space required by a laser system is small.
- In order to keep the emission of welding particles low, an exact adjustment of the welding process is required.
- Welding of highly reflective surfaces is problematic as they do not absorb the energy evenly, which causes uneven heat distribution and local overheating.

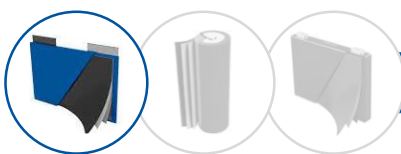

### Ultrasonic welding

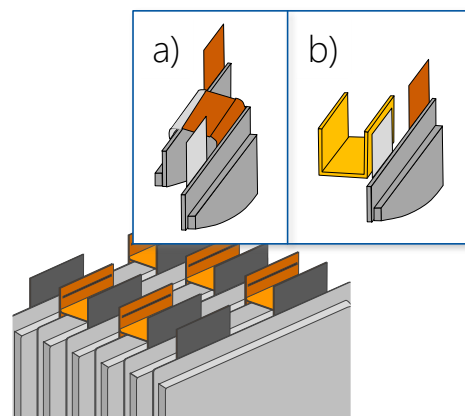

- Ultrasonic vibrations create friction between materials until the necessary heat of fusion has been introduced. After cooling and solidification, a homogeneous bond is formed.
- The cells are either: (a) directly contacted with each other (cell-to-cell) or (b) by means of busbars (cell-to-busbar).
- In this process, low electrical resistance and high connection strength are achieved.
- The accessibility of the contact areas and the high space requirement of the sonotrode limit the process.



### Resistance welding

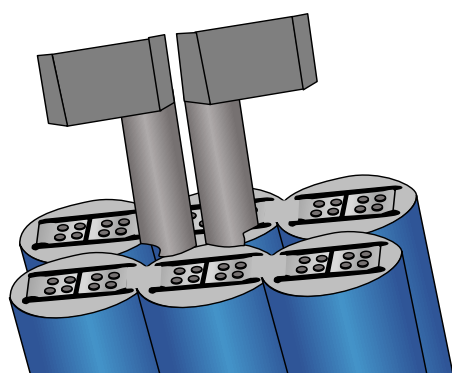

- In resistance welding, a voltage is applied between the welding fixture and the contact point.
- The electrical resistance causes local heating of the materials and leads to their fusion.
- Resistance welding allows a high degree of automation and short process times.
- The joining process is problematic for dissimilar and highly conductive materials.



### Wire bonding

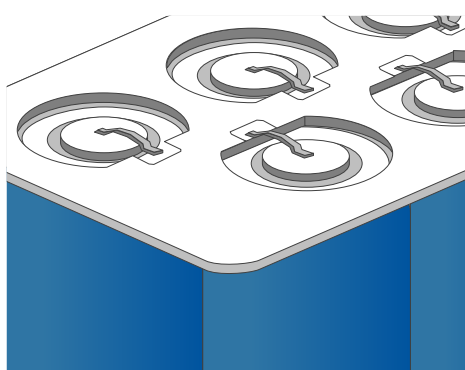

- Cell poles are connected to the current collector plate by means of thin bonding wires.
- Electrical contact is made under the combined action of heat, pressure and ultrasound.
- The bonding wires act as cell-specific fuses.
- Compensation for misalignment and height offset of the cells resulting from the plug-in connections.
- The bond strength of the bonding wires is comparatively low.

# Tensioning of the cells

## Module production

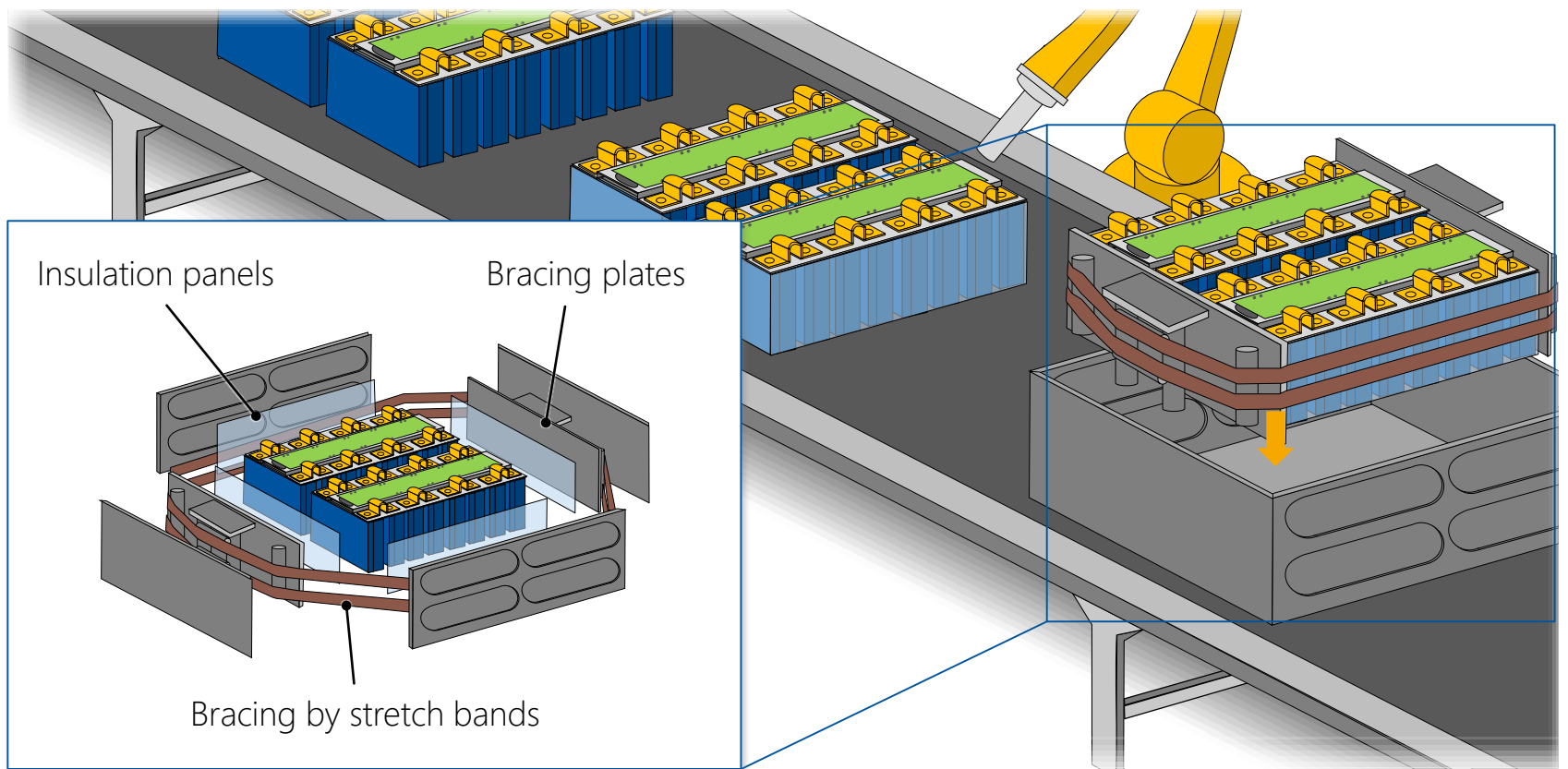
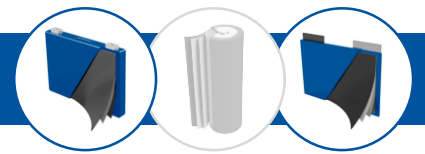

Pack production

### Production process

- The stacked prismatic cells or braced pouch cells are fixed by a clamping device, bandaging or by the module body itself. Alternatively, the clamping can already be carried out before the cells are contacted.
- Plastic plates, foils or fluids are used to dissipate heat and for electrical insulation. In the event of an accident, these should also prevent or ideally interrupt a chain reaction of the cells as far as possible.
- Positioning and precise insertion into the module and subsequent fastening of the cell compound with the housing..
- *Optional:* Fire protection coatings or thermal protection pads can be used to minimize fire propagation time. In addition, gap fillers or thermal interface materials are used to create a heat conduction path between the battery module and the cooling system and improve heat dissipation to the environment.

#### Process parameters & requirements

- Precise positioning and reliable fixing of the cell composite in the module housing
- Precise compliance with specified tightening torques and clamping forces

#### Quality parameters

- Positional accuracy in the housing
- Safe electrical insulation and heat dissipation in the module
- Uniform contact pressure via realized cell tensioning

#### Current technology alternatives

- Alternative methods of bracing (bracing by straps, threaded rods, bolting or welded clamps).

#### Innovations / Trends

- Higher level of automation in assembly and quality control
- Sustainable welding or joining technology for easy recycling

Production costs\* [excerpt]

Investment for machinery & equipment: € 1.0 – 1.5 m

\* PEM study by RWTH Aachen University: Capacity of the pack: 150 Ah, pack voltage: 400 V, production capacity: 4 GWh/a

# Battery safety

## Additional safety components in the battery design

### Mechanical load and fixation of the cells

- The expansion and contraction of the cells causes an oscillating pressure load that increases continuously during the service life.
- The applied pressure has a decisive influence on the aging behavior of the cells. A light pressure load (approx. 0.3 bar – 0.5 bar) is advantageous for a long service life.
- During operation, vibrations, shocks or mechanical loads must not impair battery performance. The cells are braced to prevent damage to the cells or components and to ensure uniform pressure distribution.

### Thermal load and fire protection

- During operation, strong heat generation occurs in the cells, especially during high discharge and charge processes.
- Heat dissipation must occur as efficiently as possible to regulate the temperature within the module.
- Due to the risk of overheating of the cell resulting in a strong exothermic reaction (thermal runaway), the spread of fire or heat must be prevented.

### Insulation and electromagnetic compatibility

- The electrical components in the battery module may be affected by electromagnetic interference. To prevent short circuits or unwanted electrical connections, electrical components in the battery module must be insulated.
- Insulation and shielding materials can be used to ensure protection against short circuits and electromagnetic interference.

*Additional safety components are integrated into the module or pack to ensure protection against external influences during operation and to optimize thermal, mechanical and electrical performance.*

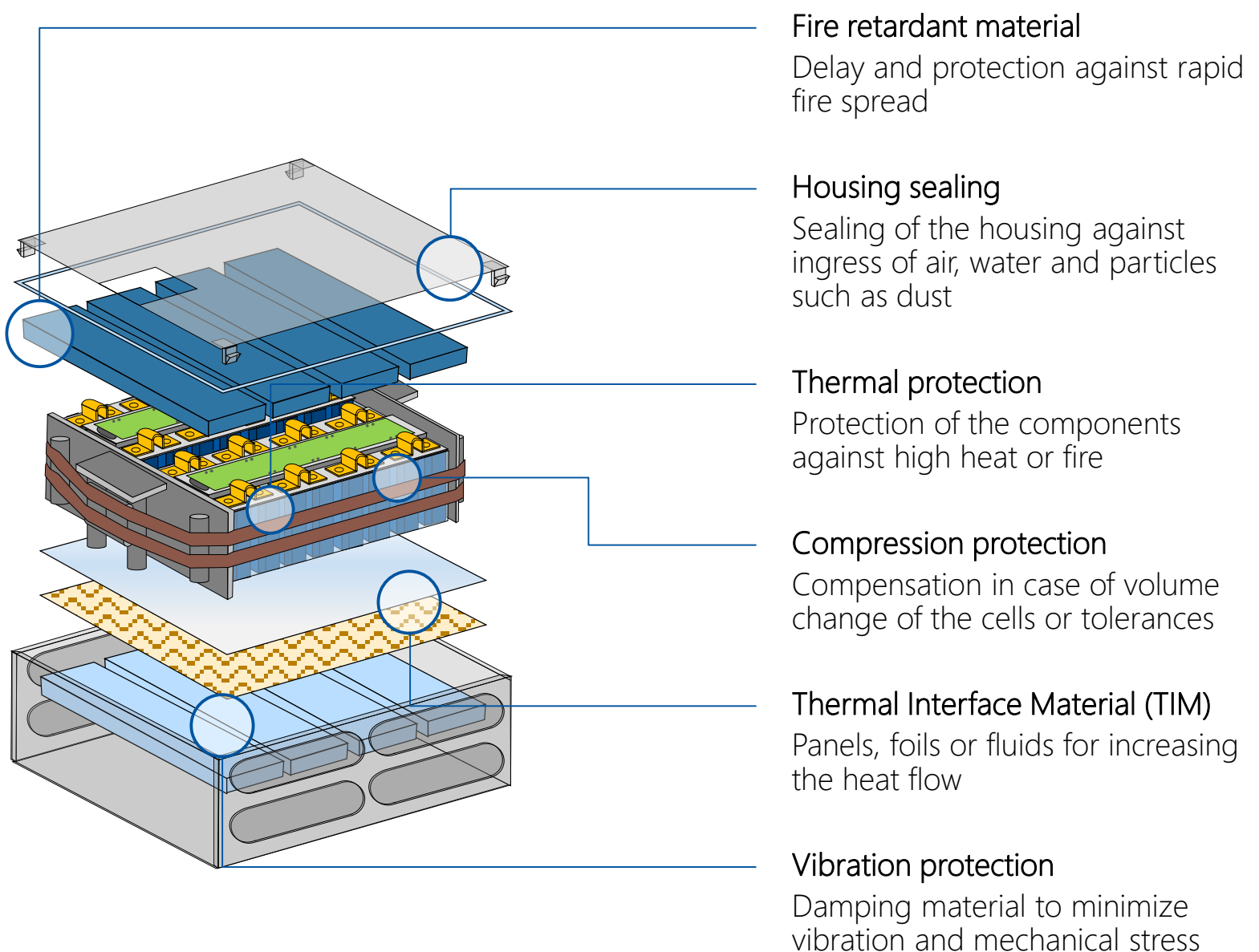



# Module final assembly

## Module production

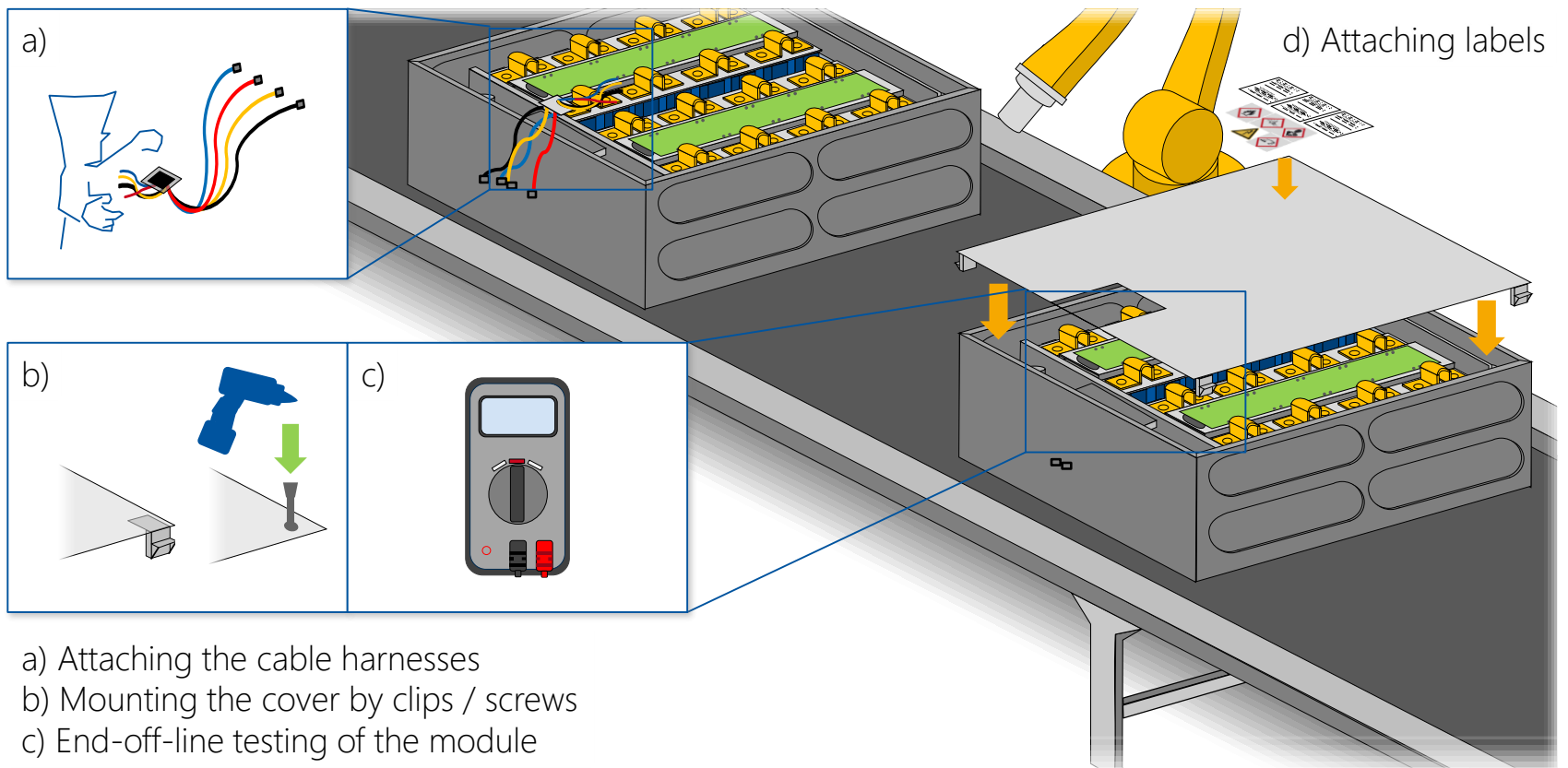
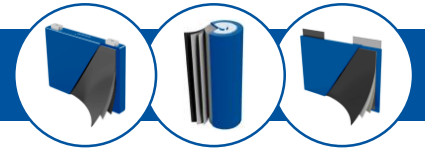

- a) Attaching the cable harnesses
- b) Mounting the cover by clips / screws
- c) End-of-line testing of the module

Pack production

### Production process

- Attachment of the wire harnesses and connectors (power & COM cables).
- Preparation of the module connections for control and interface communication.
- Covering and sealing of the module housing by mounting a cover plate.
- Requirement-specific end-of-line testing of the module for, among other things:
  - Dimensional accuracy and external irregularities (optical tolerances)
  - Functionality of communication and sensors (software test)
  - Impermeability of the module (technical cleanliness)
- Attachment of protective caps, product labels and warnings.
- Packaging and preparation for transport, storage or further processing as part of pack production.

#### Process parameters & requirements

- Handling and safety instructions
- Ensuring transport safety (cables, connections, protective caps, etc.)
- Tight housing closure due to correct tightening torques and sequence
- Functional connection of all electrical components

#### Quality parameters

- Tightness and protection against penetration of moisture and dirt
- Clamp-free and damage-free mounting of the cover plate (integrity of the contacting systems)
- High-voltage strength
- Tensile strength of the module

#### Current technology alternatives

- Gluing or welding of the end plate instead of bolting
- Use of high-throughput test systems

#### Innovations / Trends

- Wireless BMS for removing and reduction of necessary cabling
- Composite materials (housing and cover) for lightweight construction and increased structural stability

Production costs\* [excerpt]

Investment for machinery & equipment: € 0.2 – 0.4 m

\* PEM study by RWTH Aachen University: Capacity of the pack: 150 Ah, pack voltage: 400 V, production capacity: 4 GWh/a

# Mounting the modules

## Pack production

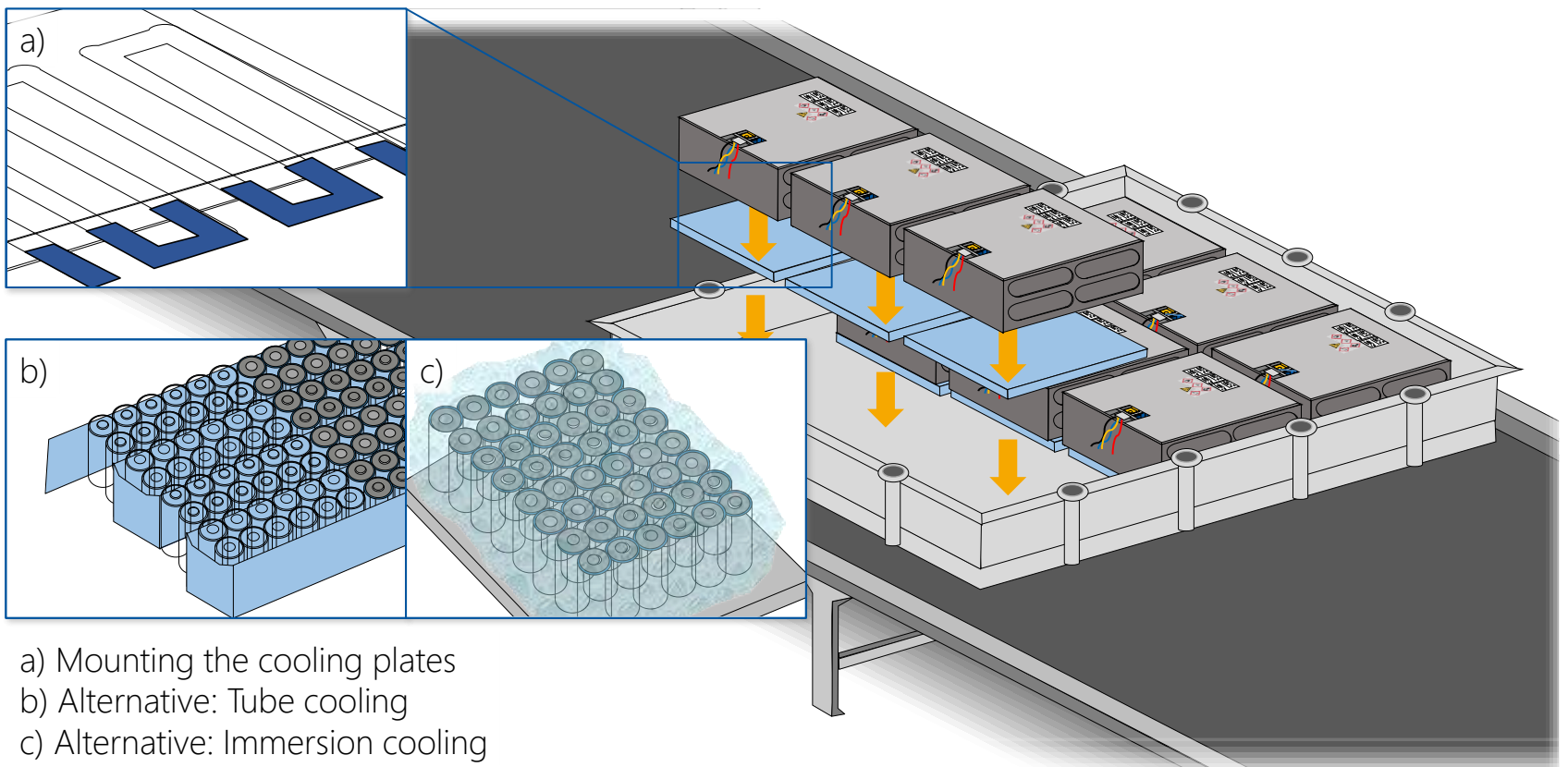

- a) Mounting the cooling plates
- b) Alternative: Tube cooling
- c) Alternative: Immersion cooling

## Module production

### Production process

- Mounting of a centralized or decentralized cooling system in the battery pack to cool the modules during operation (winter heating function if necessary).
- Depending on the structure within the modules, electrical insulation, fire protection, filler or thermal conduction materials can be used to reduce fire spread time or improve heat dissipation.
- Insertion of the battery modules into the pack housing by appropriate grippers or end of arm tooling (EOAT). This step is repeated until all modules are inserted.
- Setup and wiring of battery packs vary greatly between applications and suppliers (e.g. 4S3P, 6S3P, 12S1P etc. / S: Serial, P: Parallel).
- Fixing of the battery modules by means of screw or alternatively adhesive connections. If necessary, fixing of safety components (crash structures, fusing, etc.).

### Process parameters & requirements

- Correct alignment of the modules
- Tightening torques and correct tightening sequence of the screw connections
- Functional connection of all electrical components

### Quality parameters

- Positioning accuracy of the cooling
- Correct wiring
- Stiffness of the battery pack

### Current technology alternatives

- Cooling systems such as liquid cooling, tube cooling, cold plates and modules with integrated cooling
- Bonding instead of screw connection

### Innovations / Trends

- Use of assembly strategies that facilitate recycling and reuse
- Alternative housing materials to increase design flexibility

Production costs\* [excerpt]

Investment for machinery & equipment: € 1.8 – 2.2 m

\* PEM study by RWTH Aachen University: Capacity of the pack: 150 Ah, pack voltage: 400 V, production capacity: 4 GWh/a

# Cooling systems

## Pack production

### Base plate

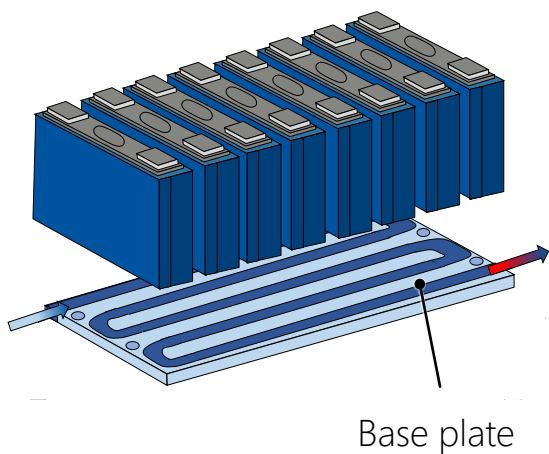

- The base plate is integrated into battery pack tray and actively cooling the cells while heat is dissipated via a cooling fluid at the bottom.
- Usually, the bottom plate is designed as a single element, which makes it easy to install.
- Due to the one-sided heat dissipation, the bottom plate provides a comparatively uneven and inefficient overall cooling performance.

### Intermediate elements

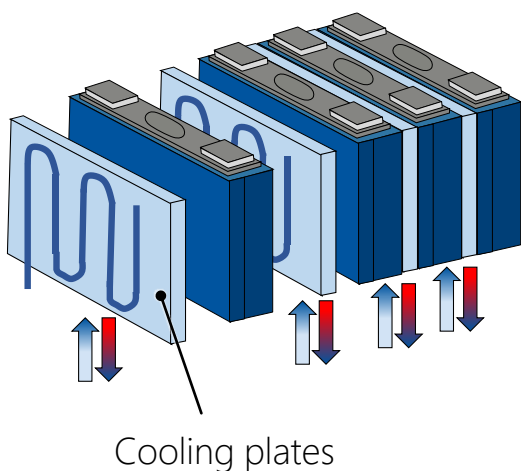

- The cooling plates are used as an intermediate layer between the cells.
- With this design, a large proportion of the cell surface is surrounded by cooling elements, which ensures a high cooling capacity.
- Compared to the base plate, this structure is very complex and requires a time-consuming assembly process.

### Hose cooling

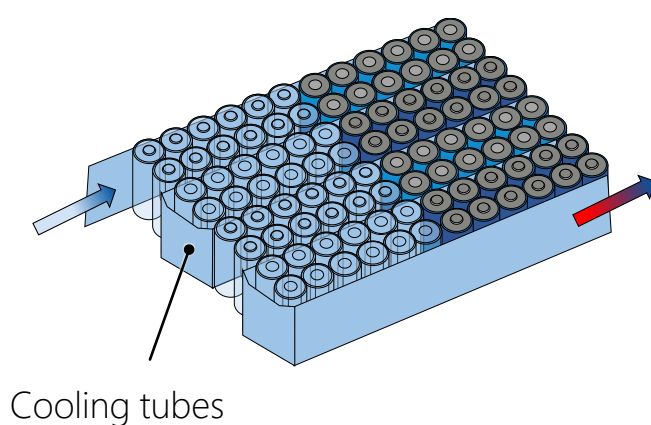

- The cooling fluid is routed around the cells by means of hose routing.
- Each module has separate connections to the cooling system.
- Tube cooling offers high level of standardisation in the module design and high cooling capacity.
- The assembly of a hose cooling system is demanding and complex due to the required structure.

### Immersion cooling

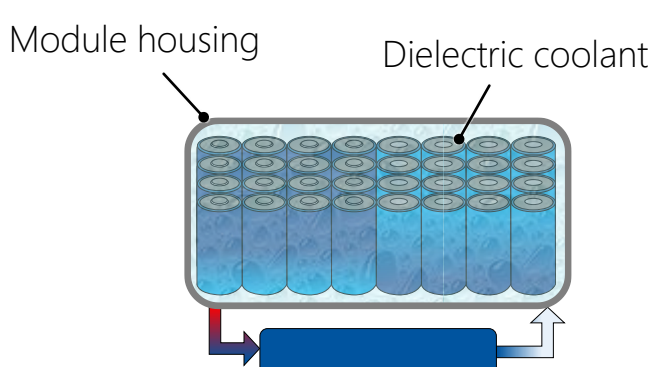

- The battery module is flooded with a non-conductive fluid and cooled.
- This design offers the highest cooling capacity and maximum flexibility in battery design.
- There are high demands on the module's tightness and a high installation effort as well as high maintenance costs.

# Assembly of internal components

## Pack production

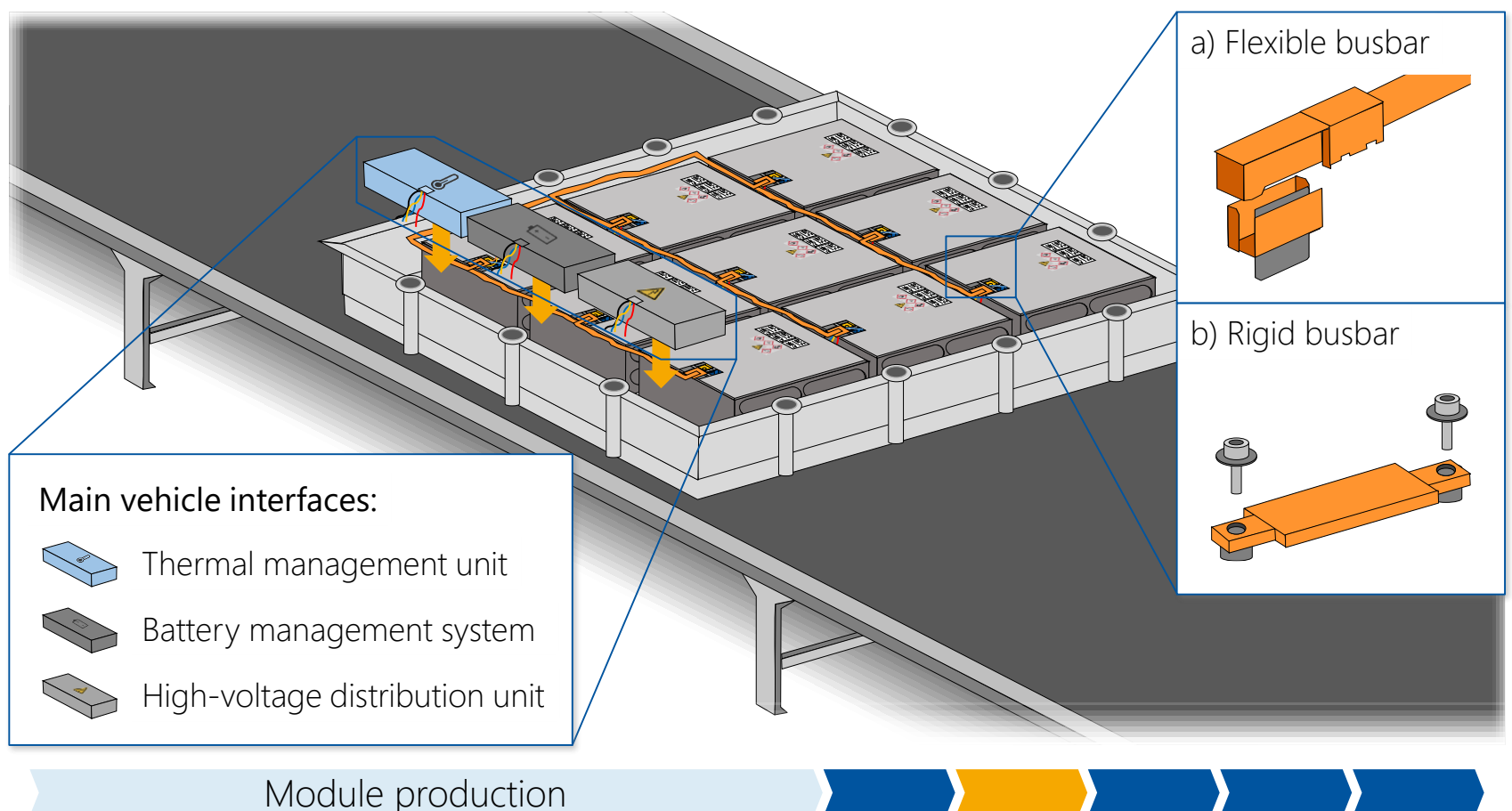

## Production process

- Positioning of the thermal management unit in the holder provided for this purpose and connection to cooling elements in the pack housing.
- Positioning and fastening the high-voltage distribution unit (consisting of relays, fuses, pre-charge and current measurement system, insulation monitoring, etc.)
- Connecting high voltage (HV) and low voltage (LV) wiring harness to modules and peripherals
- Assembly and cabling of the battery management system (BMS master) to control the thermal management unit, slave boards and HV distribution unit.
- Interconnecting battery modules using flexible or rigid busbars with fasteners such as clips, screws or latches. Electrical insulation with thermal interface material (TIM).
- Installation of connectors, valves and plugs on the outer casing in preparation for vehicle integration.

### Process parameters & requirements

- Installation of the flexible cables can usually only be carried out by a trained employee
- Functional connection of all electrical components

### Quality parameters

- Positioning accuracy of internal components, wiring and busbars
- Functionality of the modules and peripherals
- No measurable leakage currents

### Current technology alternatives

- Automated assembly
- Flexible busbars

### Innovations / Trends

- Poka-Yoke for the prevention of faulty assembly
- Flexible battery designs
- Design for service (e.g. maintenance)

Production costs\* [excerpt]

Investment for machinery & equipment: € 0.9 – 1.2 m

\* PEM study by RWTH Aachen University: Capacity of the pack: 150 Ah, pack voltage: 400 V, production capacity: 4 GWh/a

# Sealing & Leak testing

## Pack production

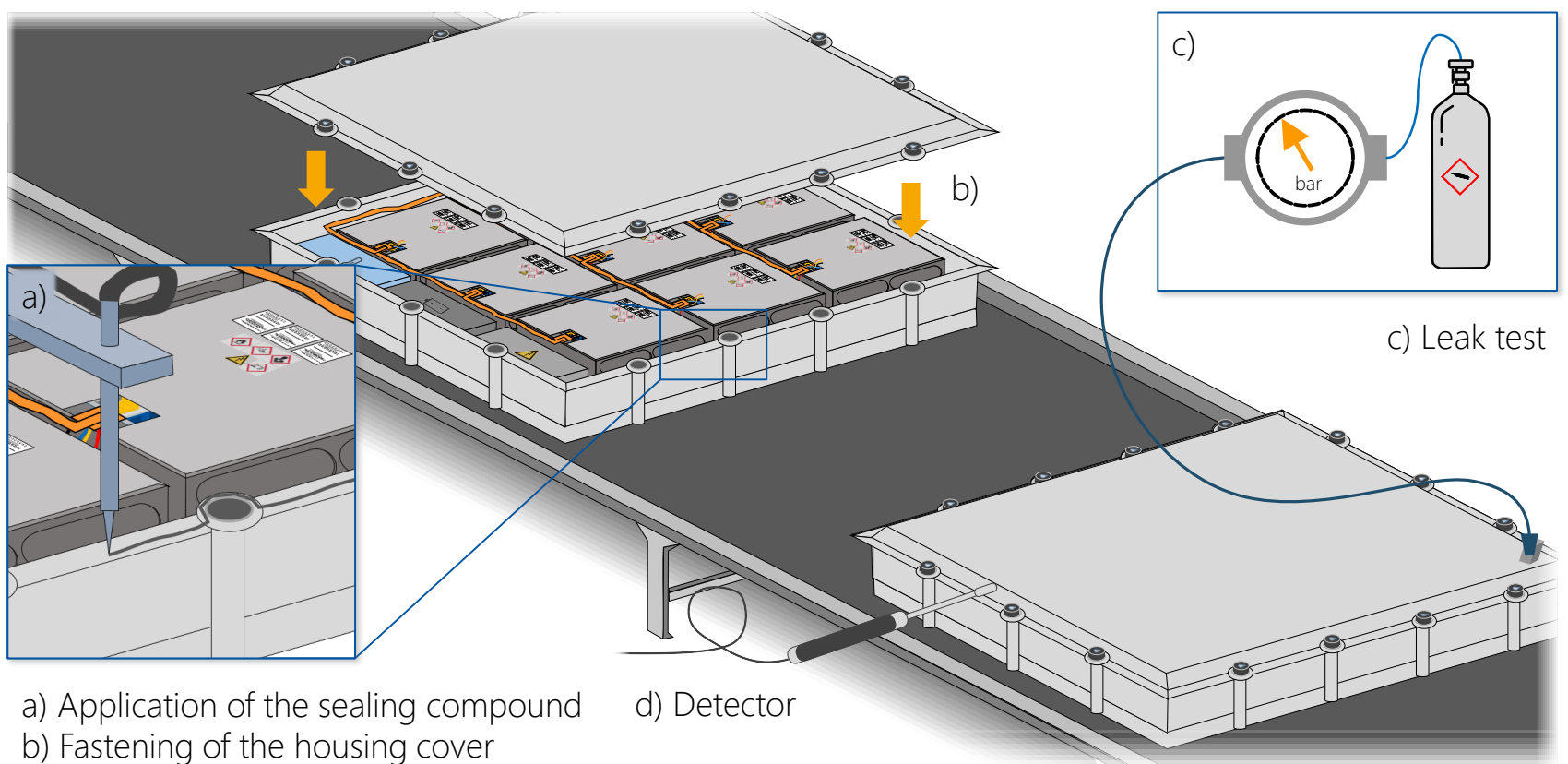

### Module production

## Production process

- Attach or apply the seals (e.g. rubber seal, sprayed or bonded seals) to the edge of the housing or lid.
- Place the upper part of the housing or lid and connect it (e.g. by screwing) to the battery pack housing.
- Install a bursting disc in the battery pack housing to secure the pressure of the battery pack and to ensure safety during operation.
- Leak test of the housing by triggering the bursting disc or testing device. In case of high sensitivity to external influences and strict pressure limits, additional detectors (e.g. sniffer probes) are used.
- If necessary, check the tightness of the cooling circuit using leak detectors (sniff test) or suitable tracer gas (e.g. helium).

### Process parameters & requirements

- Seal must be suitable for stress during operation
- Bursting disc as safety valve
- During the test, bursting of the enclosure in case of overpressure must be prevented

### Quality parameters

- Dosing accuracy of the adhesive
- Quality of the adhesive bead
- Tightness of the battery housing
- Robustness of the housing cover

### Current technology alternatives

- Differential pressure testing
- Leak testing with tracer gases
- Sniff test to reduce external influences

### Innovations / Trends

- Detachable joints instead of curing adhesive for easy disassembly

Production costs\* [excerpt]

Investment for machinery & equipment: € 1.8 – 2.0 m

\* PEM study by RWTH Aachen University: Capacity of the pack: 150 Ah, pack voltage: 400 V, production capacity: 4 GWh/a

# Charging & Flashing

## Pack production

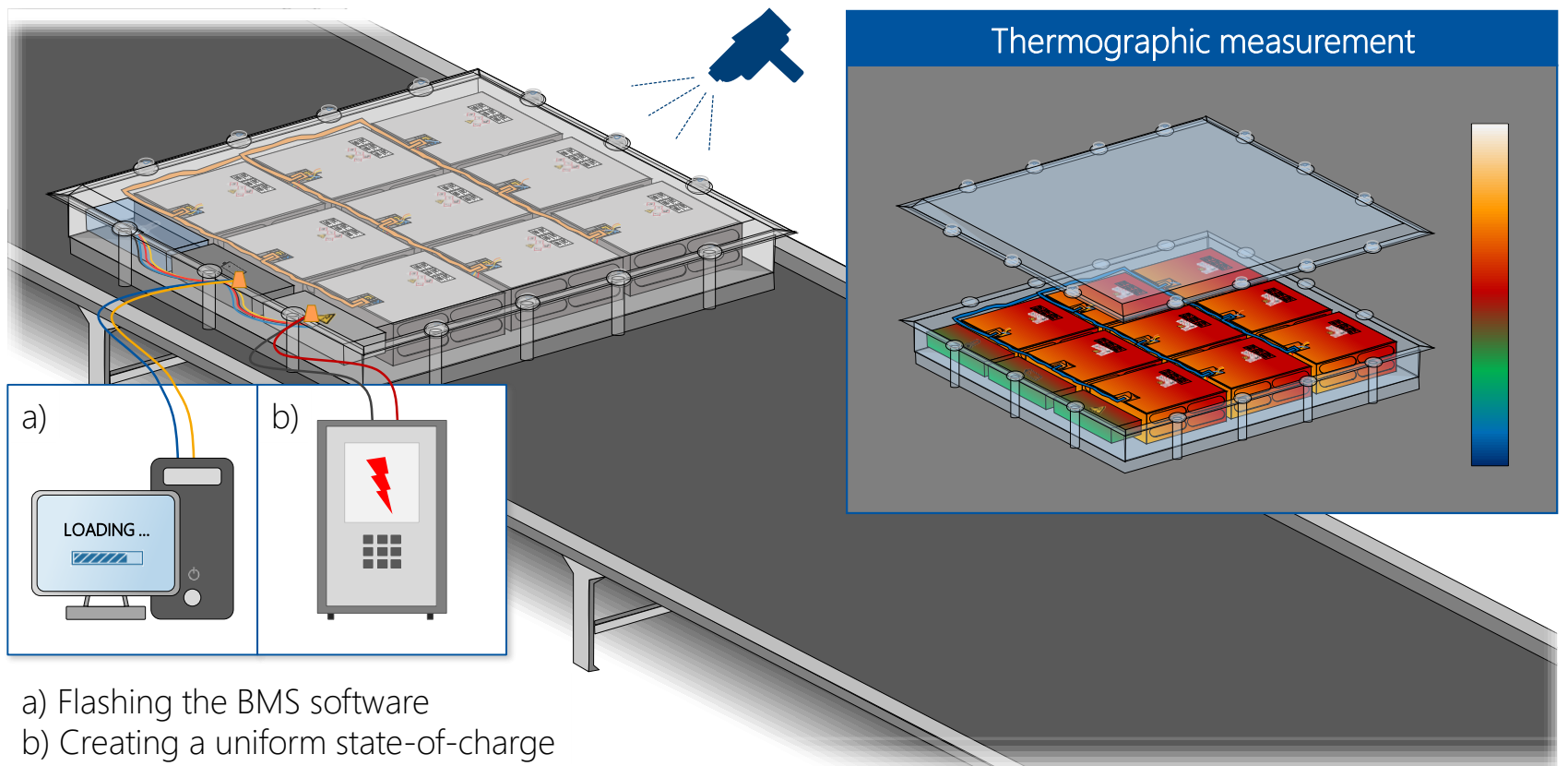

a) Flashing the BMS software  
b) Creating a uniform state-of-charge

### Module production

## Production process

- Connecting the BMS to a computer and "flashing" it with the latest software through a system analysis program.
- Verifying correct operation of all systems through the analysis program.
- Establishing the desired, uniform state-of-charge of all cells.
- If necessary, monitoring of the welded joints and the thermal management functions during operation by means of a thermographic measuring system.

### Process parameters & requirements

- Installation of the latest software for the battery management system for the corresponding vehicle variant
- Compliance with functional tolerances
- Prevention of gas formation or fire development during the charging process

### Quality parameters

- Full functionality of all components
- Efficient cooling capacity and even temperature distribution
- No heat development during the charging process

### Current technology alternatives

- *none*

### Innovations / Trends

- *none*

Production costs\* [excerpt]

Investment for machinery & equipment: € 3.8 – 4.0 m

\* PEM study by RWTH Aachen University: Capacity of the pack: 150 Ah, pack voltage: 400 V, production capacity: 4 GWh/a

# End-of-line testing

## Pack production

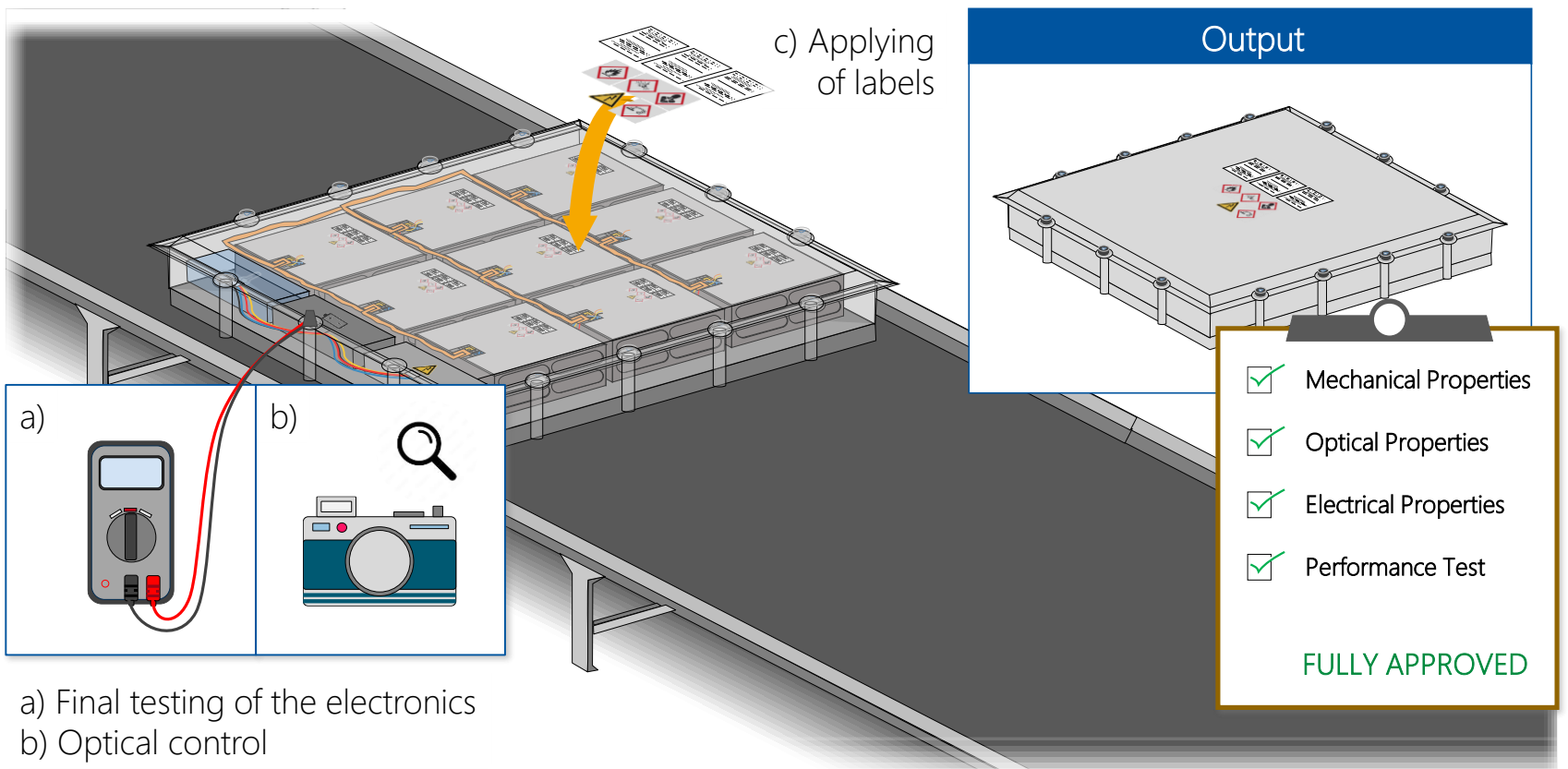

Module production

### Production process

- Connecting the test equipment to interfaces of the battery pack.
- Checking of the entire electronics by test software and visual inspection by an employee.
- Checking the smooth functioning of the BMS and its subcomponents (temperature sensors, slave board, etc.).
- Charging / discharging the battery according to defined performance profile and establishing a desired state-of-charge (SOC) for storage or vehicle assembly.
- Attaching labels, warnings and marking as "approved" for clearance of the pack.
- Packing and transporting the battery pack.

#### Process parameters & requirements

- Criteria catalog for comprehensive testing and functional checks
- Defined delivery condition in coordination with vehicle assembly
- Training of employees necessary

#### Quality parameters

- Fulfillment of all quality tests

#### Current technology alternatives

- Upstream balancing of modules in goods receipt or in holding positions within the production line

#### Innovations / Trends

- Data-based life cycle management of vehicle battery systems (e.g. Battery Passport)

Production costs\* [excerpt]

Investment for machinery & equipment: € 3.0 – 3.2 m

\* PEM study by RWTH Aachen University: Capacity of the pack: 150 Ah, pack voltage: 400 V, production capacity: 4 GWh/a

# Line configurations for module and pack production

## Segments of the production line

- The production line of a battery modules and packs has three main areas with major differences in terms of batch sizes, process speeds and safety requirements.
- From the point of view of factory layout, the assembly line can therefore be divided into cell-to-stack, stack-to-module and module-to-pack.

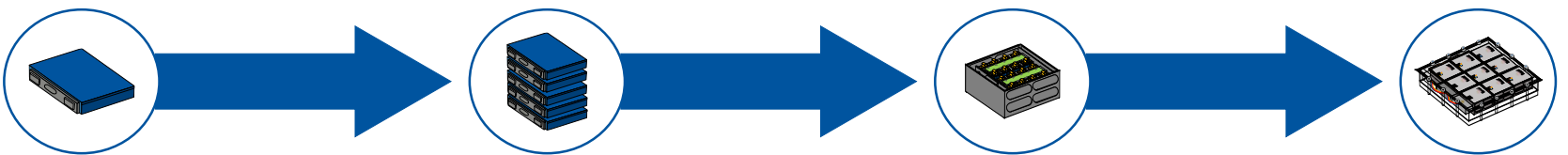

### Cell-to-Stack:

- In this area, the individual cells are assembled to form a cell cluster.
- It is characterized by a high batch size and short process times.

### Stack-to-Module:

- The batch size tapers off considerably as the cell clusters are inserted into the module.
- The high-voltage area begins once the cells are contacted.

### Module-to-Pack:

- After inserting the modules into the pack, the assembly has the smallest batch size.
- Extensive testing has significantly increased process times.

## Layout planning

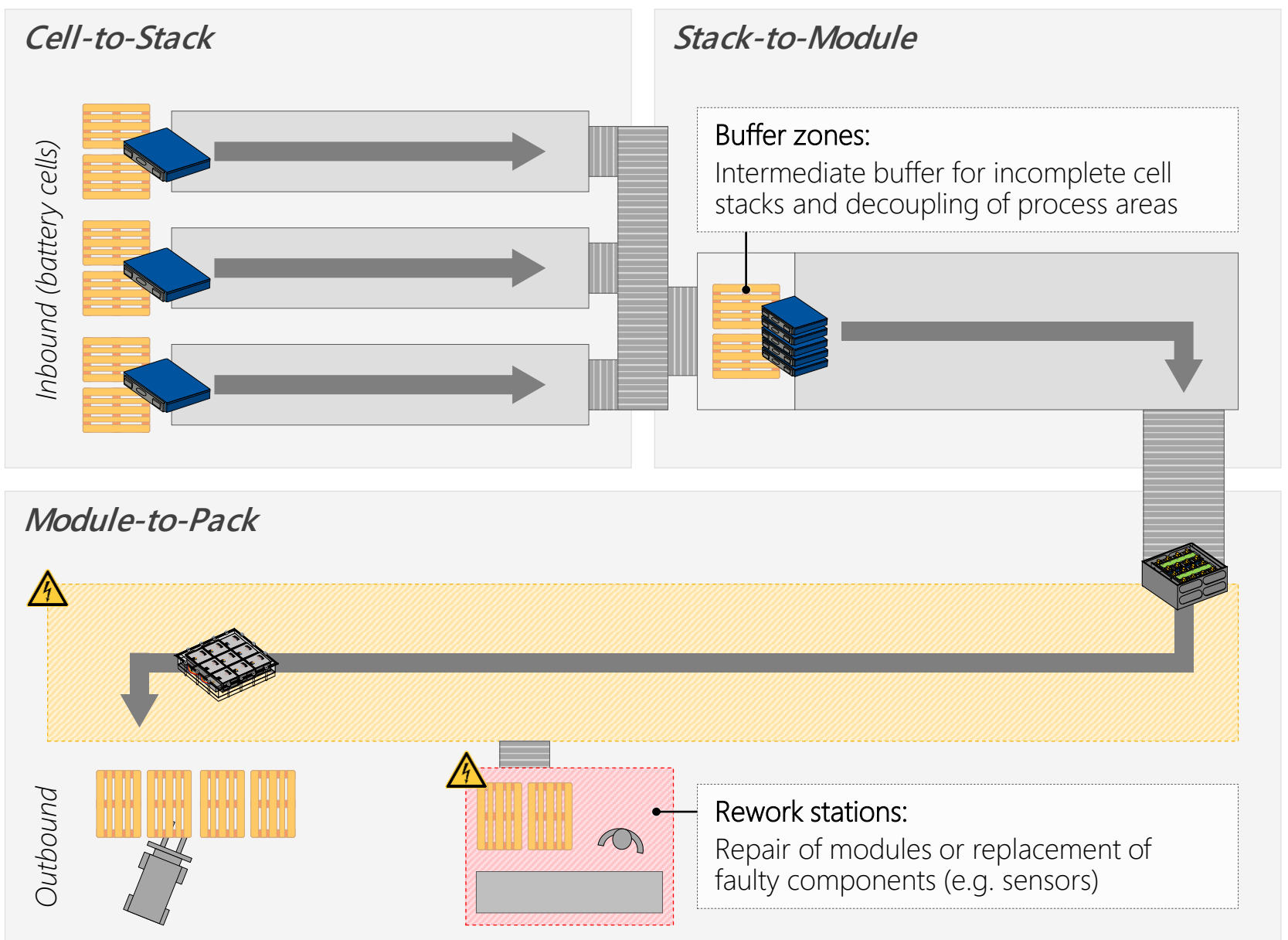

High-voltage area



Rework area (for trained personnel only)

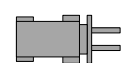

Logistics

*Future line concepts are highly automated and yet very flexible. Integrated buffer and rework stations avoid potential downtime and allow the time-consuming and complex assembly process to be decoupled.*



# Overview of potential hazards

## Safety measure in module and pack production

### Chemical hazards

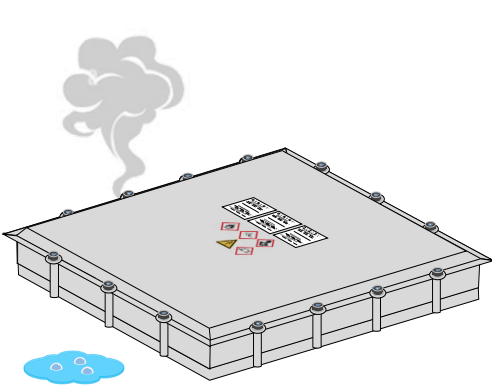

- Leakage of the electrolyte due to defects of the battery cell. The electrolyte liquid consists of toxic solvents.
- Operation outside the operating limits leads to venting of the cell. The gases produced are highly toxic.
- Formation of hydrofluoric acid on contact of the electrolyte with humidity (e.g. of the environment).

### Thermal and mechanical hazards

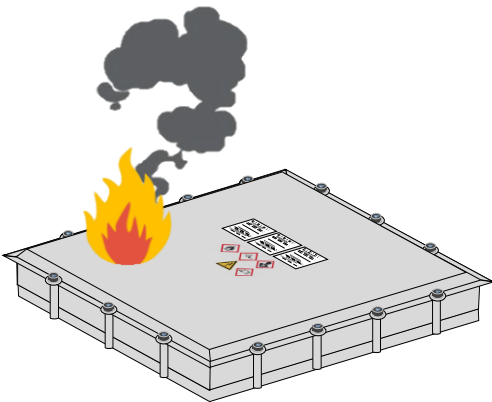

- Overheating of the cell due to a self-reinforcing exothermic reaction (thermal runaway).
- Fire and explosion hazard due to exponential increase in pressure and temperature.
- Generation of a chain reaction in the context of a thermal runaway.

### Electrical hazards

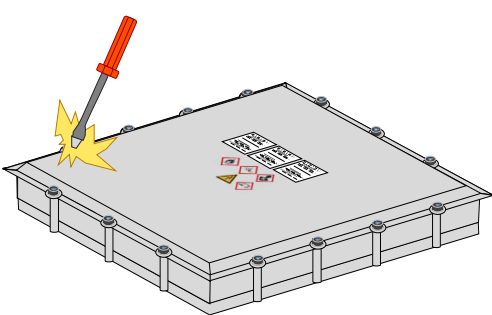

- Operating voltage can reach a range that is hazardous to health.
- Risk of internal and external short circuits.
- Muscle cramps or ventricular fibrillation due to electric body current.
- Risk of burns due to electric arcs.

## Safety measures for compliant production

*The production of battery modules and packs is associated with a variety of safety risks, which require special measures for occupational health and safety.*

#### Technical:

- Pole caps for terminals
- Light barriers in stations
- Battery safety container
- Fire protection (walls)
- Fume hoods and air ventilation

#### Organizational:

- Marking and labeling
- Protective measures against electric shock
- Safety clearances
- Emergency conducts in case of incidents

#### Personal:

- Protective equipment
- Insulated HV tools
- High-voltage training for responsible staff
- Safety body showers
- First-aid training

# Online Industry Guide

Key to battery production

Are you looking for strong solutions for battery production? Do you want to set up a production line or are you looking for process development partners?

The new overview from the VDMA Battery Production department of which companies offer which technologies along the process chain will help you find the right partners.

Available online



[www.vdma-industryguide.com/batteryproduction](http://www.vdma-industryguide.com/batteryproduction)

## Key to battery production

Battery machine manufacturing "Made in Europe" –  
Strong solutions for battery production!

The expertise of our members for machines, plants,  
materials, components and services  
for battery production!

Find the right contact person here >



Get in direct contact with the battery experts of the companies. Search the divisions within the production chain according to your needs and find the suitable companies.

You can then send the contact request via a watch list function.

# Guides

## on electromobility

Available online

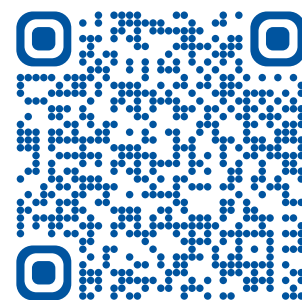

In the battery-related publications, the "Production Engineering of E-Mobility Components" (PEM) chair at RWTH Aachen University, in cooperation with the VDMA, presents the process and recycling chains from the cell to the battery pack and goes into detail about the manufacturing methods of the various components.

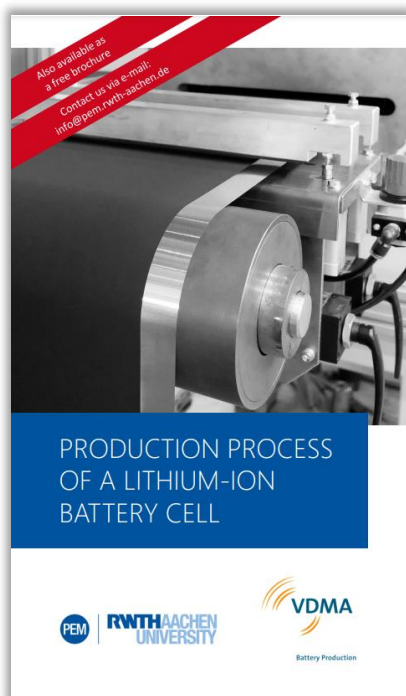

### Production process of a lithium-ion battery cell

The publication "Production process of a lithium-ion battery cell" provides a comprehensive process overview of the production of different battery cell formats from electrode manufacturing over cell assembly to cell finishing. Current trends and innovation of different process technology are also explained.

4<sup>th</sup> edition  
ISBN 978-3-947920-27-3

*Ed.*  
PEM of RWTH Aachen University & VDMA

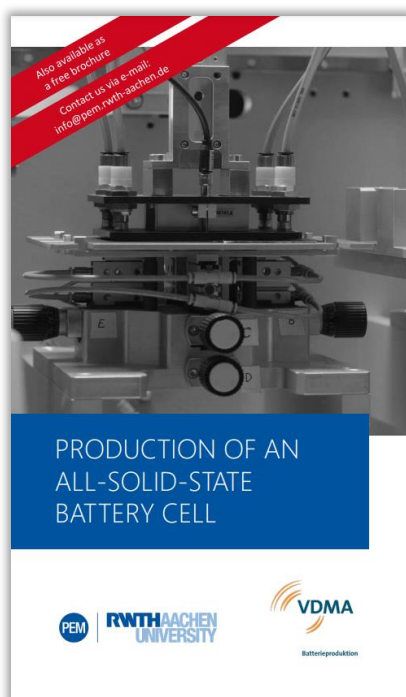

### Production process of an all-solid-state battery cell

The publication "Production process of an all-solid-state battery cell" explains the production technologies and chains for the three electrolyte classes of the all-solid-state battery cell. In addition, the possible transferability of competencies from the production of lithium-ion battery cells is illuminated.

2<sup>nd</sup> edition  
ISBN 978-3-947920-29-7

*Ed.*  
PEM of RWTH Aachen University & VDMA

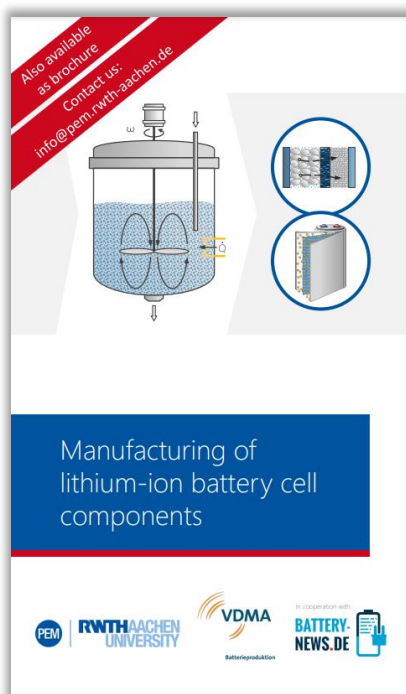

### Manufacturing of lithium-ion battery cell components

1<sup>st</sup> edition  
ISBN 978-3-947920-06-8

### Recycling of lithium-ion batteries

1<sup>st</sup> edition  
ISBN 978-3-947920-11-2



# Guides

## on electromobility

In its series of "Guide to E-Motor Production and Fuel Cell Production" articles, the chair "Production Engineering of E-Mobility Components" (PEM) of RWTH Aachen University presents further components for electric mobility.

Available online



### Production process of a hairpin stator

The guide "Production process of a hairpin stator" covers the processes involved in manufacturing hairpin stators as the predominant construction method for automotive traction applications, from dressing the wire to hairpin production, assembly and interconnection, through to impregnation and testing.

2<sup>nd</sup> edition  
ISBN 978-3-947920-19-8

Ed.  
PEM of RWTH Aachen University

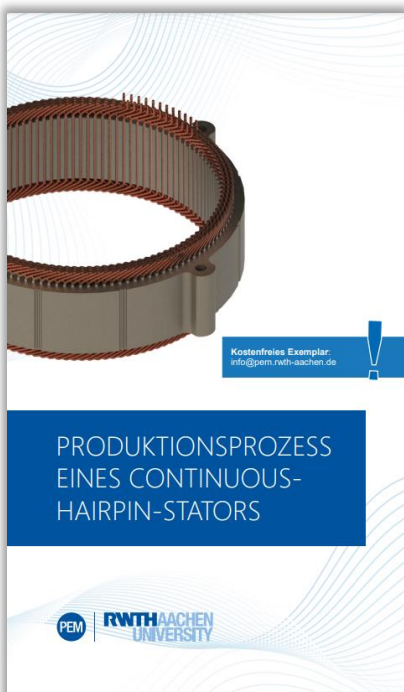

### Production process of a continuous hairpin stator

1<sup>st</sup> edition  
ISBN 978-3-947920-20-4

### Production processes of rotors

1<sup>st</sup> edition  
ISBN 978-3-947920-22-8



### Production of fuel cell systems

2<sup>nd</sup> edition  
ISBN 978-3-947920-13-6

### Production of fuel cell components

2<sup>nd</sup> edition  
ISBN 978-3-947920-15-0

